

# **Operating Reference**

## **Agilent Technologies 8757D Scalar Network Analyzer**



**Agilent Technologies**

**Manufacturing Part Number: 08757-90169**

**Master Set Part Number: 08757-90109**

**Printed in USA**

**Print Date: November 2000**

**Supersedes: March 1993**

© Agilent Technologies, Inc. 1993, 2000

---

## **Hewlett-Packard to Agilent Technologies Transition**

This manual may contain references to HP or Hewlett-Packard. Please note that Hewlett-Packard's former test and measurement, semiconductor products and chemical analysis businesses are now part of Agilent Technologies. To reduce potential confusion, the only change to product numbers and names has been in the company name prefix: where a product number/name was HP XXXX the current name/number is now Agilent XXXX. For example, model number HP8648 is now model number Agilent 8648.

---

## **Documentation Warranty**

THE MATERIAL CONTAINED IN THIS DOCUMENT IS PROVIDED "AS IS," AND IS SUBJECT TO BEING CHANGED, WITHOUT NOTICE, IN FUTURE EDITIONS. FURTHER, TO THE MAXIMUM EXTENT PERMITTED BY APPLICABLE LAW, AGILENT DISCLAIMS ALL WARRANTIES, EITHER EXPRESS OR IMPLIED WITH REGARD TO THIS MANUAL AND ANY INFORMATION CONTAINED HEREIN, INCLUDING BUT NOT LIMITED TO THE IMPLIED WARRANTIES OF MERCHANTABILITY AND FITNESS FOR A PARTICULAR PURPOSE. AGILENT SHALL NOT BE LIABLE FOR ERRORS OR FOR INCIDENTAL OR CONSEQUENTIAL DAMAGES IN CONNECTION WITH THE FURNISHING, USE, OR PERFORMANCE OF THIS DOCUMENT OR ANY INFORMATION CONTAINED HEREIN. SHOULD AGILENT AND THE USER HAVE A SEPARATE WRITTEN AGREEMENT WITH WARRANTY TERMS COVERING THE MATERIAL IN THIS DOCUMENT THAT CONFLICT WITH THESE TERMS, THE WARRANTY TERMS IN THE SEPARATE AGREEMENT WILL CONTROL.

---

## **DFARS/Restricted Rights Notice**

If software is for use in the performance of a U.S. Government prime contract or subcontract, Software is delivered and licensed as "Commercial computer software" as defined in DFAR 252.227-7014 (June 1995), or as a "commercial item" as defined in FAR 2.101(a) or as "Restricted computer software" as defined in FAR 52.227-19 (June 1987) or any equivalent agency regulation or contract clause. Use, duplication or disclosure of Software is subject to Agilent Technologies' standard commercial license terms, and non-DOD Departments and Agencies of the U.S. Government will receive no greater than Restricted Rights as defined in FAR 52.227-19(c)(1-2) (June 1987). U.S. Government users will receive no greater than Limited Rights as defined in FAR 52.227-14 (June 1987) or DFAR 252.227-7015 (b)(2) (November 1995), as applicable in any technical data.

---

---

## Printing Copies of Documentation from the Web

To print copies of documentation from the Web, download the PDF file from the Agilent web site:

- Go to <http://www.agilent.com>.
  - Enter the document's part number (located on the title page) in the **Quick Search** box.
  - Click GO.
  - Click on the hyperlink for the document.
  - Click the printer icon located in the tool bar.
-

# Contacting Agilent

This information supersedes all prior HP contact information.

**Online assistance:** [www.agilent.com/find/assist](http://www.agilent.com/find/assist)

Americas			
<b>Brazil</b> <i>(tel)</i> (+55) 11 3351 7012 <i>(fax)</i> (+55) 11 3351 7024	<b>Canada</b> <i>(tel)</i> 888 447 7378 <i>(fax)</i> 905 282 6495	<b>Mexico</b> <i>(tel)</i> 1 800 254 2440 <i>(fax)</i> 1 800 254 4222	<b>United States</b> <i>(tel)</i> 800 829 4444 <i>(alt)</i> (+1) 303 662 3998 <i>(fax)</i> 800 829 4433
Asia Pacific and Japan			
<b>Australia</b> <i>(tel)</i> 1 800 225 574 <i>(fax)</i> 1 800 681 776 <i>(fax)</i> 1 800 225 539	<b>China</b> <i>(tel)</i> 800 810 0508 <i>(alt)</i> 800 810 0510 <i>(fax)</i> 800 810 0507 <i>(fax)</i> 800 810 0362	<b>Hong Kong</b> <i>(tel)</i> 800 933 229 <i>(fax)</i> 800 900 701	<b>India</b> <i>(tel)</i> 1600 112 626 <i>(fax)</i> 1600 112 727 <i>(fax)</i> 1600 113 040
<b>Japan (Bench)</b> <i>(tel)</i> 0120 32 0119 <i>(alt)</i> (+81) 426 56 7799 <i>(fax)</i> 0120 01 2144	<b>Japan (On-Site)</b> <i>(tel)</i> 0120 802 363 <i>(alt)</i> (+81) 426 56 7498 <i>(fax)</i> (+81) 426 60 8953	<b>Singapore</b> <i>(tel)</i> 1 800 275 0880 <i>(fax)</i> (+65) 6755 1235 <i>(fax)</i> (+65) 6755 1214	<b>South Korea</b> <i>(tel)</i> 080 778 0011 <i>(fax)</i> 080 778 0013
<b>Taiwan</b> <i>(tel)</i> 0800 047 669 <i>(fax)</i> 0800 047 667 <i>(fax)</i> 886 3492 0779	<b>Thailand</b> <i>(tel)</i> 1 800 2758 5822 <i>(alt)</i> (+66) 2267 5913 <i>(fax)</i> 1 800 656 336	<b>Malaysia</b> <i>(tel)</i> 1800 880 399 <i>(fax)</i> 1800 801 054	
Europe			
<b>Austria</b> <i>(tel)</i> 0820 87 44 11* <i>(fax)</i> 0820 87 44 22	<b>Belgium</b> <i>(tel)</i> (+32) (0)2 404 9340 <i>(alt)</i> (+32) (0)2 404 9000 <i>(fax)</i> (+32) (0)2 404 9395	<b>Denmark</b> <i>(tel)</i> (+45) 7013 1515 <i>(alt)</i> (+45) 7013 7313 <i>(fax)</i> (+45) 7013 1555	<b>Finland</b> <i>(tel)</i> (+358) 10 855 2100 <i>(fax)</i> (+358) (0) 10 855 2923
<b>France</b> <i>(tel)</i> 0825 010 700* <i>(alt)</i> (+33) (0)1 6453 5623 <i>(fax)</i> 0825 010 701*	<b>Germany</b> <i>(tel)</i> 01805 24 6333* <i>(alt)</i> 01805 24 6330* <i>(fax)</i> 01805 24 6336*	<b>Ireland</b> <i>(tel)</i> (+353) (0)1 890 924 204 <i>(alt)</i> (+353) (0)1 890 924 206 <i>(fax)</i> (+353) (0)1 890 924 024	<b>Israel</b> <i>(tel)</i> (+972) 3 9288 500 <i>(fax)</i> (+972) 3 9288 501
<b>Italy</b> <i>(tel)</i> (+39) (0)2 9260 8484 <i>(fax)</i> (+39) (0)2 9544 1175	<b>Luxemburg</b> <i>(tel)</i> (+32) (0)2 404 9340 <i>(alt)</i> (+32) (0)2 404 9000 <i>(fax)</i> (+32) (0)2 404 9395	<b>Netherlands</b> <i>(tel)</i> (+31) (0)20 547 2111 <i>(alt)</i> (+31) (0)20 547 2000 <i>(fax)</i> (+31) (0)20 547 2190	<b>Russia</b> <i>(tel)</i> (+7) 095 797 3963 <i>(alt)</i> (+7) 095 797 3900 <i>(fax)</i> (+7) 095 797 3901
<b>Spain</b> <i>(tel)</i> (+34) 91 631 3300 <i>(alt)</i> (+34) 91 631 3000 <i>(fax)</i> (+34) 91 631 3301	<b>Sweden</b> <i>(tel)</i> 0200 88 22 55* <i>(alt)</i> (+46) (0)8 5064 8686 <i>(fax)</i> 020 120 2266*	<b>Switzerland (French)</b> <i>(tel)</i> 0800 80 5353 opt. 2* <i>(alt)</i> (+33) (0)1 6453 5623 <i>(fax)</i> (+41) (0)22 567 5313	<b>Switzerland (German)</b> <i>(tel)</i> 0800 80 5353 opt. 1* <i>(alt)</i> (+49) (0)7031 464 6333 <i>(fax)</i> (+41) (0)1 272 7373
<b>Switzerland (Italian)</b> <i>(tel)</i> 0800 80 5353 opt. 3* <i>(alt)</i> (+39) (0)2 9260 8484 <i>(fax)</i> (+41) (0)22 567 5314	<b>United Kingdom</b> <i>(tel)</i> (+44) (0)7004 666666 <i>(alt)</i> (+44) (0)7004 123123 <i>(fax)</i> (+44) (0)7004 444555		
<i>(tel)</i> = primary telephone number; <i>(alt)</i> = alternate telephone number; <i>(fax)</i> = FAX number; * = in country number			

---

## Operating Reference

### Added Benefits of the HP/Agilent 8757D (Revision 5.1 and above)

The 8757D provides all of the same features as the HP/Agilent 8757A and HP/Agilent 8757C, but also provides the following features:

- improved absolute power accuracy with Option 002 50 MHz power calibrator
- compatibility with HP/Agilent 85037A/B precision detectors in addition to all HP/Agilent scalar detectors and bridges
- improved accuracy for mixer measurements from the detector frequency function
- Detector Offset:
  1. extended amplitude display range with detector offsets up to  $\pm 60$  dB
  2. the ability to measure a detector offset with the power calibrator to compensate for RF attenuators
  3. detector offsets are zeroed at preset
- four channel keys for easier menu use and access (channel number keys toggle the channels active and inactive)
- four display formats have uncoupled scale factors and reference values:
  1. `MEM`
  2. `MEAS`
  3. `MEAS-MEM` and
  4. SWR
- SWR display is allowed on any channel
- limit lines may be used with any number of trace points for any channel
- improved measurement speed
- cursor frequency readout for applications where an HP-IB sweeper is not used (frequencies are set by labels `START FREQ` and `STOP FREQ`)
- data recalled from disk may be reformatted or smoothed

### Added Benefits of the 8757D (Revision 6.1 and above)

The 8757D (revision 6.0) provides all of the same features as the 8757D (revision 5.1) plus the following features:

- improved measurement speed
- clock feature (appearance of date and time on hardcopies and disk files)
- HP/Agilent 83750 Series source compatibility
  - interpolated markers
  - ten available markers
  - improved frequency accuracy

## Using this Reference

Use this reference to help you operate the analyzer locally. For additional information, see the *User's Guide*, also included in this section (Local Operation). The *User's Guide* describes general measurement setups and includes typical measurement examples.

This document provides the following information:

- HP/Agilent 8757D operating features:
  - front and rear panel features
  - hardkey operation
  - softkey operation
  - softkey menu structure maps
- operator's check
- measurement applications

## Finding a **Hardkey** Description

This document divides the front panel keys (hardkeys) into the functional groups labeled on the analyzer front panel.

- CHANNEL
- FUNCTION
- ENTRY
- INSTRUMENT STATE

To find a front panel key description:

1. Locate the key in the index.
2. Turn to the page listed for that key.

## Finding a **Softkey** Description

When you press most front panel keys, one or more softkey menus is displayed. To find a softkey description:

1. Locate the key in the index.
2. Turn to the page listed for that key.

Softkey descriptions, included with each front panel key description, appear in the order in which the analyzer displays the softkeys, from the top to the bottom.

### **MORE**

This softkey presents the next menu layer.

### **PRIOR MENU**

This softkey displays the previous menu.

# Contents

---

<b>1. Front Panel Features</b>	
CRT/LCD . . . . .	1-3
HP-IB STATUS . . . . .	1-6
Detector Inputs . . . . .	1-6
Power Calibrator . . . . .	1-8
<b>2. CHANNEL</b>	
<b>3. ENTRY Area</b>	
<b>4. FUNCTION</b>	
<b>MEAS</b> — Measurement Menus . . . . .	4-2
<b>DISPLAY</b> — Display Menus . . . . .	4-4
Horizontal Display Resolution . . . . .	4-7
Display Resolution . . . . .	4-7
Measurement Resolution . . . . .	4-7
<b>SCALE</b> — Scale Menus . . . . .	4-9
<b>REF</b> — Reference Menus . . . . .	4-10
<b>CURSOR</b> — Cursor Menus . . . . .	4-11
. . . . .	4-11
Cursor Interaction with Source Markers . . . . .	4-11
Applications for Analyzer Cursors . . . . .	4-11
Applications for Source Markers . . . . .	4-12
Source Capabilities . . . . .	4-12
<b>AVG</b> — Average Menu . . . . .	4-14
<b>CAL</b> — Calibration Menus . . . . .	4-15
Self-Calibration . . . . .	4-21
Autocalibration . . . . .	4-22
Temperature Compensation . . . . .	4-22
<b>SPCL</b> — Special Menus . . . . .	4-23
<b>5. INSTRUMENT STATE</b>	
<b>SYSTEM</b> — System Menus . . . . .	5-2
<b>LOCAL</b> — Local Menu . . . . .	5-10
Changing a Default Address . . . . .	5-10
<b>SAVE</b> — Save Menus . . . . .	5-11
<b>RECALL</b> — Recall Menus . . . . .	5-17
<b>PRESET</b> — Preset Key . . . . .	5-21
Analyzer . . . . .	5-21
Source . . . . .	5-22
Plotter . . . . .	5-22
Printer . . . . .	5-22

Disk Drive . . . . .	5-23
Unchanged Analyzer Conditions . . . . .	5-23
<b>6. Rear Panel Features</b>	
<b>A. Operator's Check</b>	
Equipment Required . . . . .	A-1
Description . . . . .	A-1
Procedure . . . . .	A-2
<b>B. Softkey Menu Structure Maps</b>	
<b>C. Performing an External Calibration</b>	
Performing an External Detector Calibration with an HP 85025C . . . . .	C-1
External Detector Measurement Calibration . . . . .	C-1
Equipment required: . . . . .	C-1
AC versus DC Measurement Calibration . . . . .	C-2
Changing a Stored Measurement Calibration . . . . .	C-3
Uncalibrated Operation . . . . .	C-3
Zeroing . . . . .	C-3
<b>D. Measurement Applications</b>	
Mixer Measurements . . . . .	D-1
<b>Index</b>	



# Figures

---

1-1. The HP 8757D Front Panel . . . . .	1-1
1-2. The Analyzer CRT/LCD . . . . .	1-3
1-3. Mode Labels Description . . . . .	1-4
1-4. HP-IB STATUS Indicators . . . . .	1-6
1-5. Detector Inputs . . . . .	1-7
1-6. Power Calibrator . . . . .	1-8
2-1. CHANNEL Keys and Channel Menu . . . . .	2-1
3-1. Knob, STEP Keys and Numeric Keypad . . . . .	3-1
4-1. FUNCTION Keys . . . . .	4-1
4-2. <b>MEAS</b> Key and Measurement Menus . . . . .	4-2
4-3. <b>DISPLAY</b> Key and Display Menus . . . . .	4-4
4-4. <b>SCALE</b> Key and Scale Menu . . . . .	4-9
4-5. <b>REF</b> Key and Ref Menu . . . . .	4-10
4-6. <b>CURSOR</b> Key and Display Menus . . . . .	4-11
4-7. <b>AVG</b> Key and Average Menu . . . . .	4-14
4-8. <b>CAL</b> Key and Calibration Menus . . . . .	4-15
4-9. <b>SPCL</b> Key and Special Menus . . . . .	4-23
5-1. Instrument State Keys . . . . .	5-1
5-2. <b>SYSTEM</b> Key and System Menus . . . . .	5-2
5-3. <b>LOCAL</b> Key and Local Menu . . . . .	5-10
5-4. <b>SAVE</b> Key and Save Menus . . . . .	5-11
5-5. Directory of Stored Files . . . . .	5-14
5-6. <b>RECALL</b> Key and Recall Menus . . . . .	5-17
5-7. <b>PRESET</b> Key . . . . .	5-21
6-1. The HP 8757D Rear Panel . . . . .	6-1
A-1. Operator's Check Equipment Set-up . . . . .	A-2
B-1. HP 8757D Softkey Menu Structure Map . . . . .	B-2
B-2. HP 8757D Softkey Menu Structure Map . . . . .	B-3
B-3. HP 8757D Softkey Menu Structure Map . . . . .	B-4
B-4. HP 8757D Softkey Menu Structure Map . . . . .	B-5
D-1. Mixer Lab Equipment Set-up . . . . .	D-1

## Tables

---

1-1. Status Symbol Identification . . . . .	1-4
1-2. Status Line Description . . . . .	1-5
4-1. Minimum Sweep Time Versus Number of Points . . . . .	4-7
4-2. Measurement Ranges and Resolution . . . . .	4-7
4-3. Default Scale Per Division for Display Modes . . . . .	4-9
5-1. Example Printout for <b>PRINT DATA</b> . . . . .	5-4
5-2. Example Printout for <b>PRINT MKRS</b> . . . . .	5-5
5-3. HP-IB Default Addresses . . . . .	5-10
5-4. Source Settings Saved on Disk . . . . .	5-12
D-1. Three Mixer Measurement Cases . . . . .	D-2

## Front Panel Features

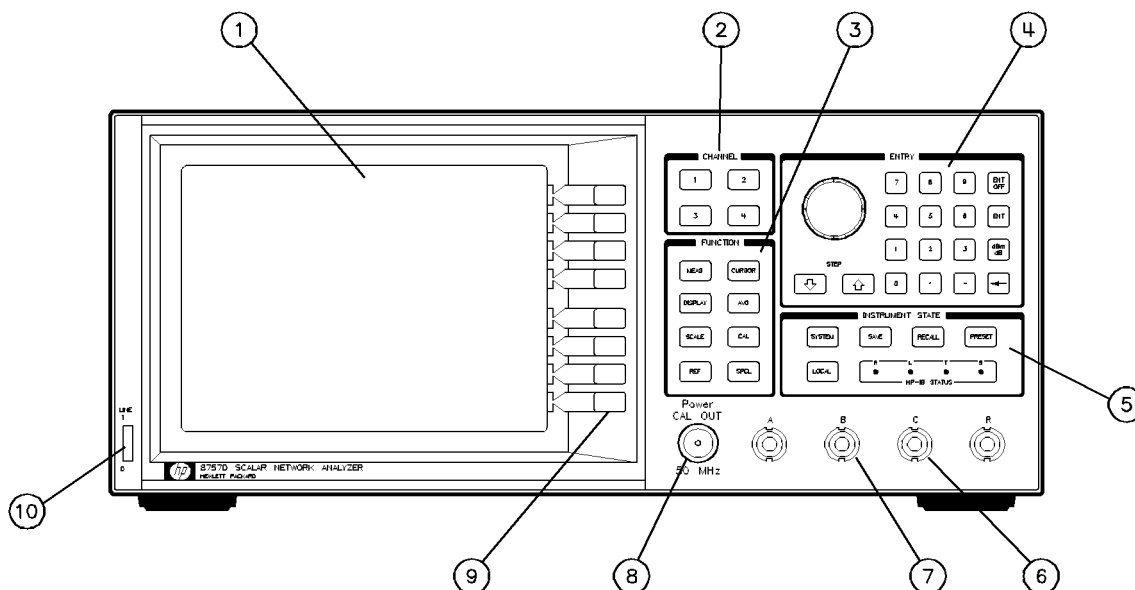

Figure 1-1. The HP 8757D Front Panel

- ① **CRT/LCD** Shows measurement annotation, softkey labels, data traces, and more.
- ② **CHANNEL** Displays a measurement channel and makes that channel active. When measurement channels are already displayed, these keys select the active measurement channel. The analyzer has five inputs (four inputs on the front panel and one auxiliary input on the rear panel) but can display up to four measurement channels.
- ③ **FUNCTION** Engages functions such as calibration and averaging.
- ④ **ENTRY** Includes knob, STEP keys, softkey menus, and numeric keypad for entering data.
- ⑤ **INSTRUMENT STATE** Controls system functions (such as plotting and defining titles) that apply to the entire instrument state, not just to a single channel.
- ⑥ **FOURTH DETECTOR INPUT** The fourth detector input is available on the Option 001 and Option 002 instruments only.
- ⑦ **DETECTOR INPUTS** Connect compatible detectors and directional bridges.

⑧ **POWER CALIBRATOR (Option 002)** Calibrates dynamic accuracy characteristics of HP 85037 Series detectors.

⑨ **SOFTKEYS** Present menu functions, and instrument status information.

⑩ **LINE**

Controls AC power to the analyzer.

---

## CRT/LCD

The analyzer displays information in several areas (see Figure 1-2).

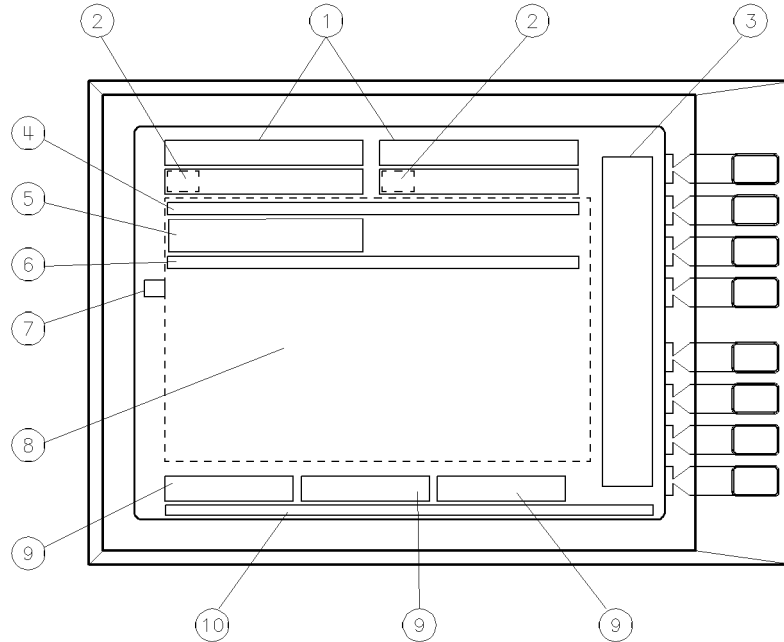

**Figure 1-2. The Analyzer CRT/LCD**

① **Mode Labels** Figure 1-3 shows each part of the mode labels area. For each channel turned on, this area shows the following:

- measurement mode (single input or ratio)
- status symbols (indicating active functions, see Table 1-1)
- cursor amplitude for active marker (with compatible sweeper)
- scale per division
- reference level value

The following locations show mode labels:

<b>Left Side of CRT/LCD</b>	<b>Right Side of CRT/LCD</b>
-----------------------------	------------------------------

Channel 1	Channel 2
-----------	-----------

Channel 3	Channel 4
-----------	-----------

A highlighted box encloses the active channel mode labels.

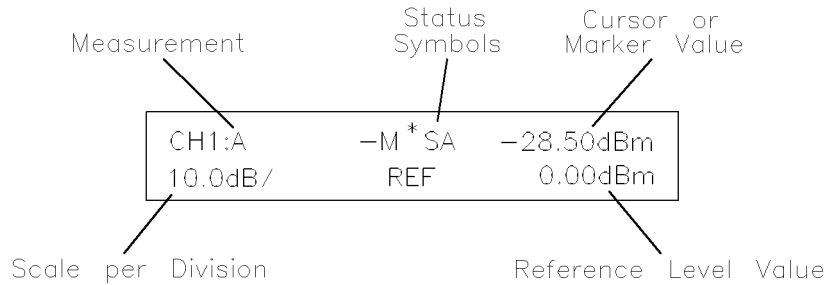

**Figure 1-3. Mode Labels Description**

**Table 1-1. Status Symbol Identification**

Status Symbol	Activated Feature	Function Key/ Instrument State Key
-M	MEASUREMENT-MINUS-MEMORY	<b>DISPLAY</b>
MEM	MEMORY	<b>DISPLAY</b>
A	AVERAGING ON	<b>AVG</b>
S	SMOOTHING ON	<b>SPCL</b>
*	ADAPTIVE NORMALIZATION ON	<b>SYSTEM</b>
U	ADAPTIVE NORMALIZATION ON (uncalibrated)	<b>SYSTEM</b>

- ② **Pass/Fail Indicators** Shows the pass/fail status based on the limit lines entered for channel 1 or 2. These indicators display *only with both channels 3 and 4 off*.
- ③ **Softkey Labels** Define the softkey functions for the menu shown. A label that is underlined and displayed with greater intensity indicates the engaged active channel function.
- ④ **Title Line** Shows the title that you have entered using the SYSTEM menu.
- ⑤ **Active Entry Area** Displays the last entry or HP-IB command function, except for preset (**PRESET**), measurement (**MEAS**), and display (**DISPLAY**).
- ⑥ **Message Line** Shows messages and warnings to the operator.
- ⑦ **Reference Line Position** Identifies the reference position for each channel with the channel number and a “>” symbol in the left margin of the graticule grid. You can position reference lines on major graticule lines.
- ⑧ **Data Display Area** Displays up to four measurement channel data traces.

- ⑨ **Frequency Labels** Displays the start, stop, and cursor (or source active marker) frequencies. The cursor frequency takes precedence over the active marker frequency. If you engage alternate sweep, the alternate sweep frequencies also appear.
- ⑩ **Status Line** Shows the current status of the analyzer (see Table 1-2). Blank entries do not apply to the current status.

**Table 1-2. Status Line Description**

AC	401	DETOFS ABCR	FRQ ABCR	MAN SS NON	CW SYSINTF OFF	UNCAL ABCR
①	②	③	④	⑤	⑥	⑦

- ① AC or DC detection mode
- ② Number of trace points:
  - 101
  - 201
  - 401
  - 801
  - 1601
- ③ Non-zero detector offset for each detector indicated
- ④ FRQ (ABCR) indicate that the DET FREQ (on/off) function is ON for the specified input (A, B, C, R).
- ⑤ Sweep mode other than standard swept mode:
  - MAN manual sweep mode
  - CW continuous wave (CW) sweep mode
  - NON nonstandard sweep mode
  - SS step sweep (available in HP 8340, 8360, and 83750 Series sources)
- ⑥ HP 8757 system interface is off
- ⑦ Uncalibrated condition for each detector (A, B, C, R) connected. This message occurs only when you turn autocalibration *off* (in the CAL menu), and an input drifts out of calibration (for more information see “Self-Calibration” in chapter 4).

---

## HP-IB STATUS



**Figure 1-4. HP-IB STATUS Indicators**

The HP-IB STATUS indicators (Figure 1-4) show the current status of the analyzer. The indicators do not update continuously. Several complete HP-IB operations can take place without any change in the displayed status.

Indicator	Analyzer Status
R	Remote operation
L	Listen mode
T	Talk mode
S	Service request (SRQ) asserted

---

## Detector Inputs

### Maximum Voltages

#### Input Voltage

1.  $\pm 7$  V
2.  $\pm .5$  V
3. +15 V to -12.6 V

#### Output Voltage

4. -12.6 V
5. +15 V



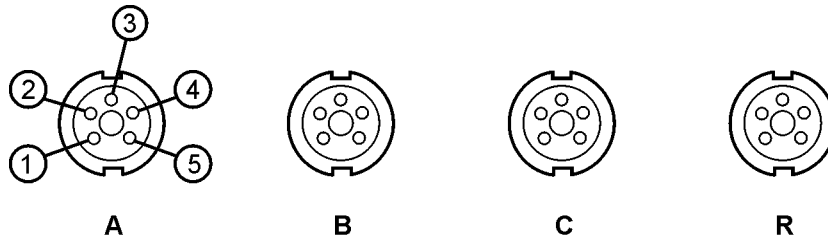

aa63d

**Figure 1-5. Detector Inputs**

Figure 1-5 shows the analyzer's detector inputs. Each input has identical characteristics and allows connection of compatible detectors and bridges.

**Input A** is typically used to connect a directional bridge for reflection measurements.

**Input B** is typically used to connect a detector for transmission measurements.

**Input C** (found on Option 001 only) is typically used to measure a fourth parameter, for example, where a device under test has more than one output.

**Input R** is typically used as the reference detector input for ratio measurements.

---

## Power Calibrator

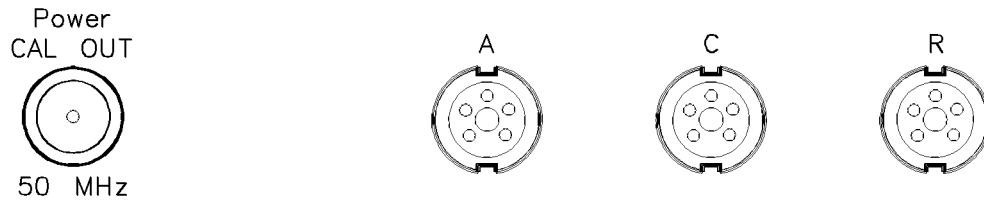

**Figure 1-6. Power Calibrator**

Figure 1-6 shows the Option 002 power calibrator output connector. Use the power calibrator (a multi-level 50 MHz reference) to calibrate the dynamic accuracy characteristics of HP 85037 Series precision detectors, as well as other HP detectors and bridges. See “Calibration Menus” in chapter 4.

## CHANNEL

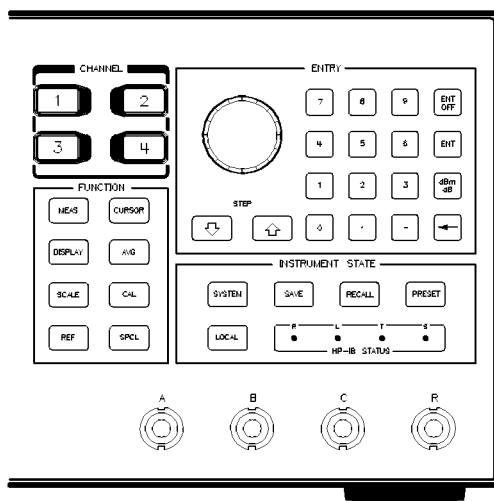

**Figure 2-1. CHANNEL Keys and Channel Menu**

Figure 2-1 shows the CHANNEL keys. A channel receives the data from the detector inputs and the analyzer displays it in a format designated by either the preset conditions or by the conditions you set from the front panel key entry.

If you press a CHANNEL key for an undisplayed measurement channel, the analyzer will display the channel and make that channel active. If you press a CHANNEL key for a displayed measurement channel, the analyzer will make that channel active. But, if you press a CHANNEL key for a displayed and active measurement channel, the analyzer will turn that channel off.

The analyzer can select data from up to five inputs (four inputs on the front panel and one auxiliary input on the rear panel) but can only measure up to four inputs at one time. The analyzer can only have one *active* channel at a time. A highlighted box encloses the active channel mode labels. Any function you select applies exclusively to the active channel but measurement data is updated to all channels simultaneously. At instrument preset, the measurements on channels 1 and 2 are displayed, with channel 1 active.

## ENTRY Area

---

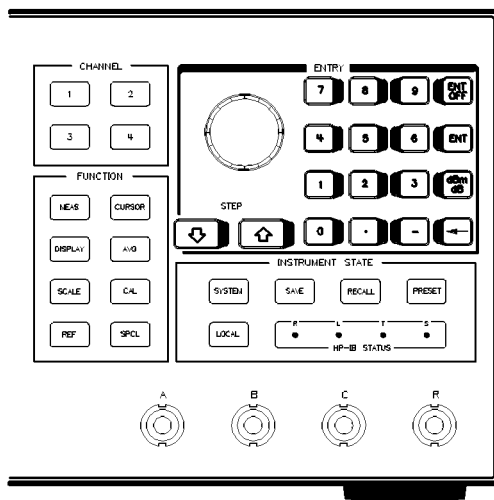

Figure 3-1. Knob, STEP Keys and Numeric Keypad

The **ENTRY** area consists of the **knob**, the **STEP** keys, and the **numeric keypad**. (See Figure 3-1.)

- Use the **knob** to change current values for various functions such as **SCALE** and **REF LEVEL**. Counter-clockwise rotation decrements the value; clockwise rotation increments the value.
- Use the **STEP** keys to increment or decrement the numerical value of a function.
- Use the **numeric keypad** digits, decimal points, and minus signs for numerical entries. Entries require using a terminator of **ENT** or **dBm/dB** (except for **SAVE** and **RECALL** entries).
- **ENT** terminates unitless entries such as averaging factors (non dBm).
- **dBm/dB** terminates numeric keypad entries for functions such as **SCALE** and **REF LEVEL**.

---

**Note**       deletes the last digit entered.

---

## FUNCTION

---

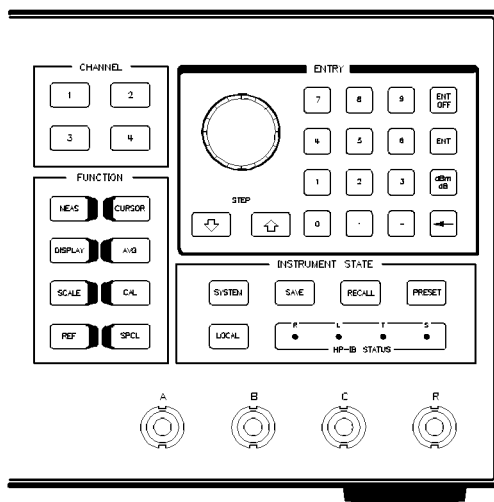

**Figure 4-1. FUNCTION Keys**

Figure 4-1 shows the FUNCTION keys. Use the eight FUNCTION keys to engage functions and present softkey menus that generally apply only to the active channel. These functions include:

- measurement modes
- display formats
- scale factors
- reference levels and positions
- cursor positioning
- averaging
- calibration
- special functions

## MEAS — Measurement Menus

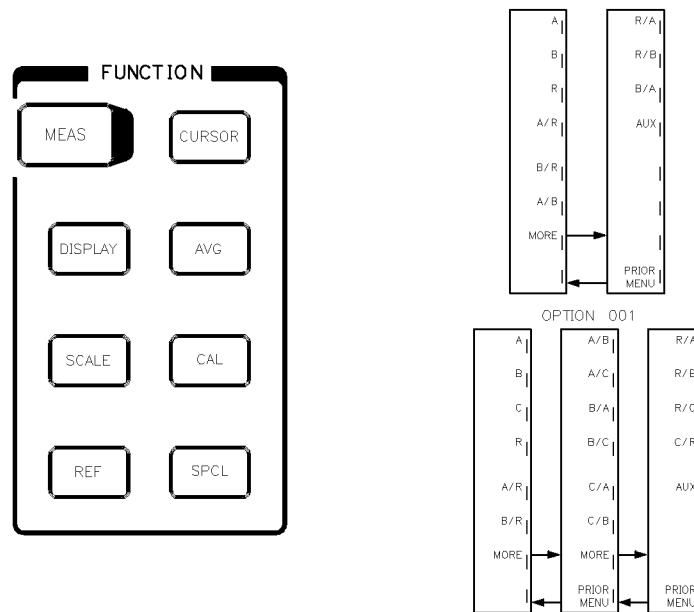

Figure 4-2. MEAS Key and Measurement Menus

The **MEAS** key presents the measurement menus (see Figure 4-2). You can select the analyzer to display either a single measurement channel or a ratio of channels.

For example:

- If you select **A**, the analyzer displays the measured value at input A (in dBm).
- If you select **A/R**, the analyzer displays the measured value at input A (in dBm) *minus* the measured value at input R (in dBm).

Because the values are in dBm, a logarithmic subtraction equals the linear division  $A/R$ , and the result is displayed in dB.

The softkey function you select applies *only* to the active channel.

---

**Note** The analyzer can measure and display up to four of the five available inputs at one time (four inputs on the front panel and one auxiliary input on the rear panel).

---

The analyzer displays the selected measurement parameter in the mode labels area next to the channel number.

- When you press **PRESET** (the green INSTRUMENT STATE key), channel 1 then presets to measure input A, and channel 2 measures input B.
- In the mode labels area, **A** appears next to **CH1:** and **B** next to **CH2:**.

**AUX** selects a voltage input from the rear panel ADC IN (+10 to -10 V) connector. The active channel displays this voltage (instead of data from a single or ratioed detector input). You can use this function to observe the control voltage input to a voltage controlled device.

DISPLAY — Display Menus

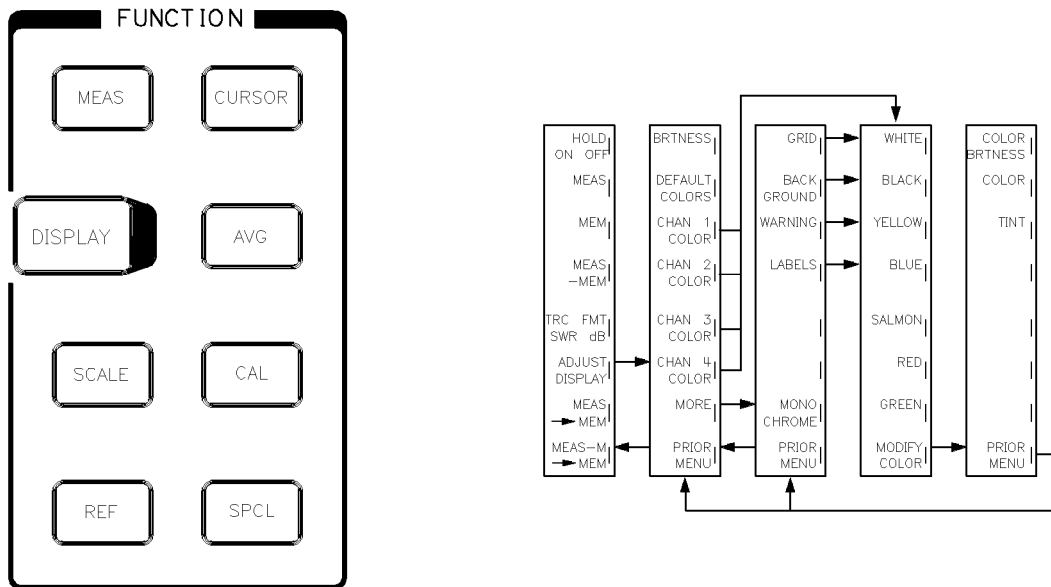

Figure 4-3. DISPLAY Key and Display Menu

The **DISPLAY** key presents the display menu (Figure 4-3), which allows you to control how the analyzer processes and displays measurement data. This menu lets you show the measurement, the data in the active channel memory, or the difference between the two. It also lets you enter the measurement (or the measurement-minus-memory) into memory.

This menu also allows you to define the colors used for analyzer display attributes such as the grid, the channel measurement traces, and the labels.

**HOLD ON OFF** freezes the active channel measurement data displayed on the analyzer.

**MEAS** shows the measurement data of the selected input (or ratio of inputs).

**MEM** shows the measurement data previously stored in the memory of that channel. When you engage this function, **MEM** appears in the status symbols section of the mode labels area for that channel.

**MEAS-MEM** shows the data previously stored in memory subtracted from the current measurement data (commonly used during calibration to produce a normalized trace). When you engage this function, **-M** appears in the status symbols section of the mode labels area for that channel.

**TRC FMT SWR dB** provides a choice of data formats for reflection data as either standing wave ratio (SWR) or return loss (dB). At preset, the data is in the return loss format.

You may select SWR for ratioed or normalized measurements on all channels and with any number of points.



---

**Remember** When you press any of these softkeys, the selected function is engaged only for the active channel, except for display adjustments.

---

**ADJUST DISPLAY** allows you to adjust the menus that display brightness and color.

**BRTNESS** lets you change the brightness (intensity) of the display. **BRTNESS:DISPLAY** appears in the active entry area, with the value last entered).

**CRT Display:** 100% is equivalent to 100 nits (units of luminance), and is the specified brightness level at shipment. If you wish, use the front panel knob or numeric keypad to enter a new value. Terminate the entry with the **ENT** key. You can adjust the brightness value down or up (although the display quality is not specified above 100%). The maximum value depends on the individual display. Preset does not change the brightness level unless you set the level below a defined minimum. You can change the minimum brightness level (see the service manual for instructions).

**LCD Display:** Use the front panel knob or numeric keypad to enter a new value. Terminate the entry with the **ENT** key. You can adjust the brightness value between 50% and 100%.

**DEFAULT COLORS** sets all analyzer display attributes to the factory-defined default colors, which were scientifically chosen to maximize your ability to discern the difference between the colors, and to comfortably and effectively view the colors. These choices accommodate most people with color-deficient vision, and provide an easy-to-view contrast.

If the default colors do not accommodate special circumstances, you can make additional adjustments. The most frequent color deficiency is the inability to distinguish red, yellow, and green. You can usually eliminate confusion with these colors by increasing the brightness between the colors (see **COLOR BRTNESS**). If you need more contrast, you can vary the degree of whiteness of the color (see **COLOR**). Usually, minor changes fix the problem.

You can also select one of the 7 factory-defined colors available from the color list. See (**CHAN x COLOR**).

**CHAN x COLOR** select the channel (x = 1, 2, 3, or 4) whose attributes (measurement trace, mode labels, limit lines, and reference level marker) you wish to adjust.

When you select this softkey, the analyzer displays the factory-defined color list.

**WHITE**, **BLACK**, **YELLOW**, **BLUE**, **SALMON**, **RED**, and **GREEN** constitute the factory-defined color list. You can use any of these colors for any of the eight analyzer display attributes.

**MODIFY COLOR** selects the menu that lets you adjust a selected color.

---

**Remember** Because you can adjust the colors of all the analyzer display attributes, you can adjust the colors such that you cannot see an attribute against the background (such as red warning labels against a red background). The softkey labels, however, remain visible.

---

## DISPLAY

**COLOR BRTNESS** changes an attribute's color brightness. When you press this softkey, the CRT displays the existing value set for that attribute. If you wish, use the front panel knob or numeric keypad to enter a new value for color brightness. As you change values, the attribute changes on the analyzer display. Press **ENT** to terminate the entry.

**COLOR** changes the degree of whiteness of the attribute's color (on a scale from white to pure color). Adjust this parameter the same way as **COLOR BRTNESS**.

**TINT** changes the attribute's hue. The continuum of hues on the color wheel range from red, through green and blue, and back to red. Adjust this parameter the same way as **COLOR BRTNESS**.

---

### Note

Preset and power on/off do not affect color selection. Color changes and adjustments remain in effect until you change them in these menus. To return to a previously defined color, write down the numeric value of the color brightness, color, and tint, and enter the appropriate value for each parameter.

---

**MORE** displays the continuation of the color adjust selections.

**GRID** selects the analyzer display grid so you can modify its color from the factory-defined color list (**WHITE**, **BLACK**, **YELLOW**, **BLUE**, **SALMON**, **RED**, and **GREEN**).

**BACKGROUND** selects the analyzer display background so you can modify its color from the factory-defined color list (**WHITE**, **BLACK**, **YELLOW**, **BLUE**, **SALMON**, **RED**, and **GREEN**).

**WARNING** selects the warning messages so you can modify the color from the factory-defined color list (**WHITE**, **BLACK**, **YELLOW**, **BLUE**, **SALMON**, **RED**, and **GREEN**).

**LABELS** selects softkey labels, status line, frequency labels, and title so you can modify the color from the factory-defined color list (**WHITE**, **BLACK**, **YELLOW**, **BLUE**, **SALMON**, **RED**, and **GREEN**).

**MONOCHROME** sets all of the analyzer display attributes to green. A highlighted box surrounds the active mode labels, and the analyzer highlights all attributes associated with the active channel.

**MEAS→MEM** stores the current measurement data into memory in dB/dBm format (even when you view the data in SWR format). You can also store voltage data (ADC IN) into memory.

**MEAS-M→MEM** stores the measurement-minus-memory (normalized trace) into memory. You can use this function only for ratio measurements.

## Horizontal Display Resolution

### Display Resolution

The analyzer's display resolution is dependent on the number of channels that you have displayed.

1601 data points available with one channel displayed

801 data points available with up to two channels displayed

401 data points available with up to four channels displayed

Use the **#TRACE POINTS** softkey in the system menu to change the number of trace points. If adaptive normalization is on, the cal data is linearly interpolated when you increase the number of trace points after a calibration.

The number of data points and number of channels displayed also affects the minimum sweep time.

**Table 4-1. Minimum Sweep Time Versus Number of Points**

Number of Points	Minimum Sweep Time (ms)			
	1 Input	2 Inputs	3 Inputs	4 Inputs
101	40	40	40	40
201	40	40	52	68
401	40	72	104	136
801	80	144	208	272
1601	160	288	N/A	N/A

### Measurement Resolution

The analyzer stores memory data at the highest resolution regardless of the display resolution, scale per division, or reference level. Table 4-2 shows the measurement resolution and range for the various display modes. The display range can exceed the limits shown when detector offsets are applied.

**Table 4-2. Measurement Ranges and Resolution**

Display Mode	Measurement Range <sup>1</sup>	Measurement Resolution	Normalized
dBm	-70 to +20 dBm	0.003 dB <sup>2</sup>	.006 dB
dB	-90 to +90 dBm	0.006 dB <sup>2</sup>	.011 dB
SWR	1.0 to 37.0	See graph below	-
AUX	-10 to +10 V <sup>3</sup>	0.70 mV	1.40 mV

1 Detector offset is not included.

2 0.01 dB for display cursor.

3 -20 to +20 V for normalized AUX.

**DISPLAY**

The analyzer calculates SWR from dB data. SWR resolution varies with the SWR measured:

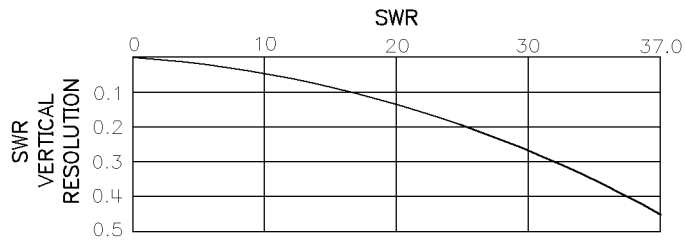

## SCALE — Scale Menus

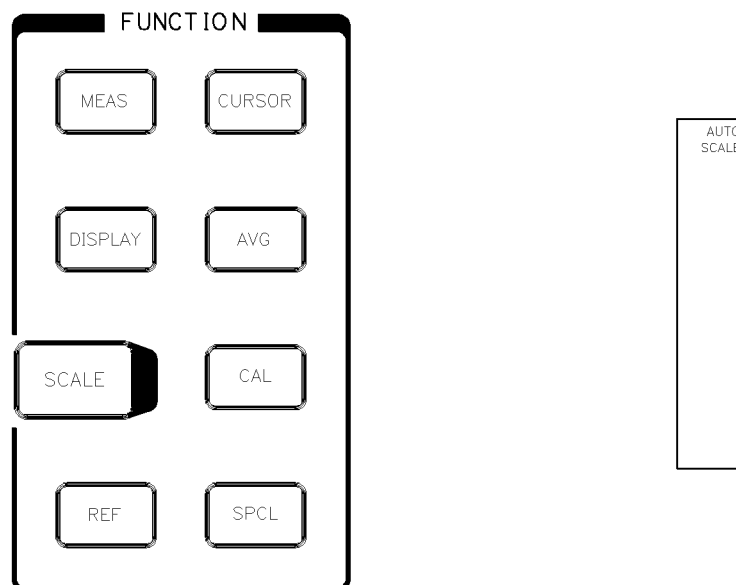

Figure 4-4. SCALE Key and Scale Menu

The **SCALE** key allows you to select the scale per division for viewing measurement data. You can change the scale factor with the knob, STEP keys, or numeric keypad. The resolution is finer when you are using the knob. Table 4-3 lists the possible choices for each display mode if you are using the step keys. If you use the keypad to enter the scale factor, you must terminate the entry with either the **dBm/dB** or **ENT** key.

**AUTOSCALE** adjusts the active trace scale and reference level to best fit within the graticule.

Table 4-3. Default Scale Per Division for Display Modes

Display Mode	Scales Per Division Using the Step Keys
dB/dBm	20, 10, 5, 1, 2, 0.5, 0.2, 0.1
SWR	10, 4, 2, 1, 0.4, 0.2, 0.1, 0.04, 0.02 SWR units
AUX (ADC IN)	5, 2.5, 1, 0.5, 0.25, 0.1, 0.05, 0.025V

**Note** The analyzer allows you to set the scale factors for MEAS, MEM, and MEAS-MEM display modes separately. This function permits you to set the optimum scale factor for each of these display types.

## REF — Reference Menus

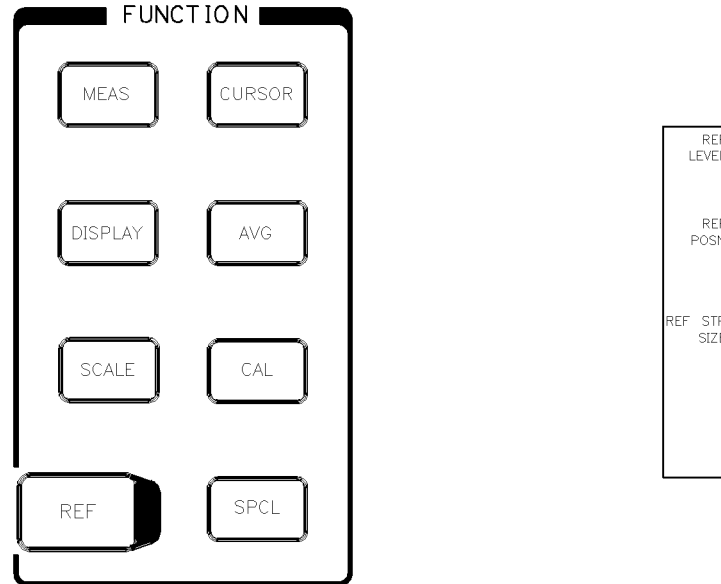

Figure 4-5. REF Key and Ref Menu

The **REF** engages the reference level function (Figure 4-5).

**REF LEVEL** lets you set the value of the reference level line (the horizontal line indicated by the reference position indicator on the left side of the analyzer display). Varying the value of this line and the scale per division lets you measure any data point and view the measurement data relative to the reference level line value. Use the knob, STEP keys, or numeric keypad to enter the reference level, and terminate the entry with the **dBm/dB** or **ENT** key.

**REF POSN** lets you set the position of the reference level line to any of the major graticules with the knob, a step key, or the numeric keypad terminated with **dBm/dB** or **GHz**. If you use the numeric keypad to position the reference, entering **0** places the reference on the bottom graticule and entering **9** places the reference on the top graticule. The channel number and the “>” symbol to the left of the analyzer display graticule show the current position of each channel’s reference level line.

**REF STP SIZE** sets the size of the steps used to increment or decrement the reference level value. You can set the reference step size with the numeric keypad, step keys, or the front panel knob. Terminate the entry with the **dBm/dB** or **ENT** key.

CURSOR — Cursor Menus

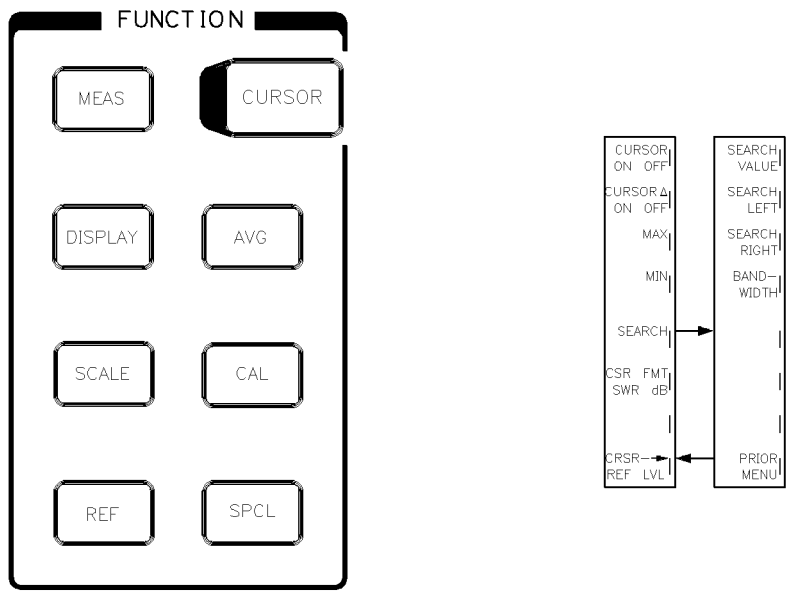

Figure 4-6. CURSOR Key and Display Menu

The CURSOR key presents the cursor menu (Figure 4-6) and engages the cursor (∇) on all channels. You can turn the front panel knob to move the cursor and quickly read the measured amplitude and frequency value of any data point. The analyzer active entry area shows the amplitude and frequency value of the data point at the active channel cursor position. The mode labels area also display the cursor values. The cursor units correspond to the measurement and display mode selected (such as dB or SWR), with the value resolved to 0.01 dB, 0.001 SWR, or 0.001 V.

**Cursor Interaction with Source Markers**

With a cursor activated, the analyzer displays the amplitude and frequency information of the cursor position. If you turn the cursor function off and activate a source marker, the analyzer will display the amplitude and frequency information of the marker position (assuming the source is compatible with the HP 8757 system interface).

Although both cursors and markers display amplitude and frequency information, their intended use is for different applications.

**Applications for Analyzer Cursors.** Cursors are particularly useful in the following situations:

- when you want to measure bandwidth
- when you want to measure one point in reference to another point
- when you only want to display ≤ 2 cursors

## CURSOR

**Applications for Source Markers.** Markers are particularly useful in the following situations:

- when you want to sweep a range designated by two markers
- when you want to display more than two markers

**Source Capabilities.** Sources that are HP-IB compatible can provide the analyzer with frequency sweep information over the system interface. The analyzer displays the conveyed source information as start, stop, and marker frequency. If your system interface is not connected, you can set the analyzer frequency labels so the analyzer will display the correct start, stop, and marker frequencies. If you engage alternate sweep, the frequency labels area displays the marker information for both sweeps.

You can activate up to five markers on an HP 8350B sweep oscillator, or an HP 8340, 8341, or 8360 Series synthesized sweeper. An HP 83750 Series sweeper allows you to activate up to ten source markers. You activate and move the source markers from the source front panel.

Most HP 8757D compatible sources create a sweep ramp of 0 to +10 volt sweep ramp. An HP 83750 Series source creates a pulse train that consists of  $1\mu$  second pulses in both continuous and step sweep modes.

**CURSOR ON OFF** toggles the cursor on or off. When the cursor is on, it appears as  $\nabla$ . You must turn the cursor off to display the marker frequency and amplitude information.

**CURSOR  $\Delta$  ON OFF** toggles the cursor delta function on and off. With the function on, a  $C\Delta$  appears at the previously set cursor position, designating a reference. The analyzer also displays another cursor that you can set to any frequency within the displayed range, using the numeric keypad or front panel knob. Then the analyzer displays the value difference between the two trace points. When you engage alternate sweep, the frequency labels area displays the cursor frequencies for both sweeps.

**MAX** positions the cursor to the maximum value point on the active channel trace for the current sweep. The analyzer does not continuously update the cursor position to the maximum point. After data is updated, select **MAX** again to relocate the cursor to the maximum point.

**MIN** positions the cursor to the minimum value point on the active channel trace.

**SEARCH** presents the search menu and lets you search for a specific value in dB or dBm on the active channel. Use this function with **CURSOR  $\Delta$  ON** to find a power difference in dB. (You cannot use search functions with SWR or AUX modes.) When you select this softkey, the analyzer displays the search menu and the active entry area shows the previous search value. To change this value, use the knob, STEP keys, or numeric keypad, terminating the entry with the **dBm/dB** or **ENT** key. Then use the search left/right softkeys to locate the entered value.

**SEARCH VALUE** lets you change the search value.

Press **CURSOR**, **SEARCH**, **SEARCH VALUE**, and enter the value, for example, **4** **dB** using the numeric keypad.

**SEARCH LEFT** causes the cursor to move left to the first position where the search value exists. When necessary, the analyzer interpolates the point between two existing values and calculates the corresponding frequency. If the analyzer cannot find the value, the analyzer displays **WARNING: Cursor Value not found.** If the search is successful, the



analyzer holds the measurement trace as noted by the displayed message Value Found: Trace Hold. By pressing any key, you can release the trace hold.

In a normalized measurement, the search function finds the n-dB point from the 0 dB reference line. In cursor  $\Delta$  mode, search values are found for the n-dB points from the  $\Delta$  cursor reference.

**SEARCH RIGHT** works the same as **SEARCH LEFT**, except that the cursor moves to the right.

**BANDWIDTH** determines the trace bandwidth at a specified value down from the maximum trace value. You can set the n-dB value for the bandwidth with the STEP keys or the numeric keypad; terminate the entry with the **dBm/dB** or **ENT** key. The analyzer searches automatically for the maximum trace amplitude, then finds the n-dB down points on both sides and shows the bandwidth in the active entry area.

**CSR FMT SWR DB** lets you view the cursor data in SWR when displaying device return loss in dB. However, if you are displaying the format in SWR, the cursor data will also be in SWR.

**CURSOR→REF LVL** sets the reference level value equal to the cursor reading. The reference position does not change, the trace moves to the reference level. By using this softkey and decreasing the scale factor, you can expand the trace about the cursor for detailed viewing.

## AVG — Average Menu

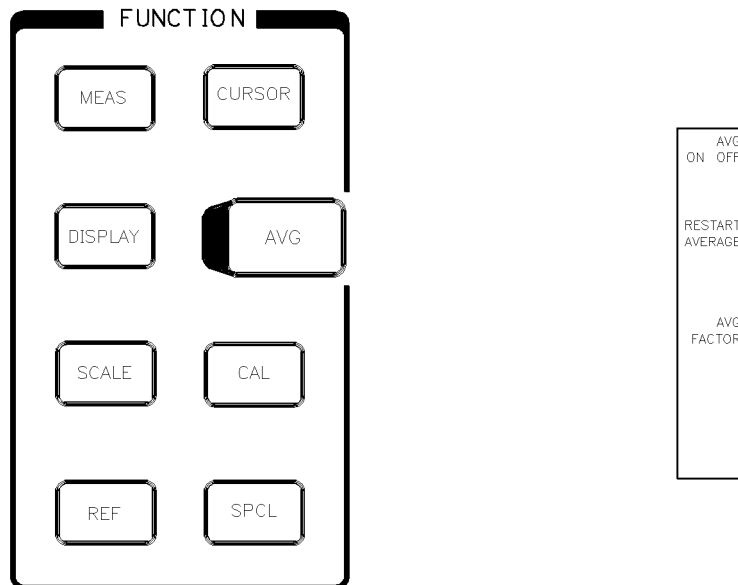

Figure 4-7. **AVG** Key and Average Menu

The **AVG** function averages a programmable number of sweeps. When you activate averaging or restart averaging, the analyzer uses an averaging factor of one on the first sweep, two on the second sweep, four on the third and fourth sweep, and increasing powers of two up to the desired averaging factor. This technique removes noise from calibration or measurement traces. The analyzer performs averaging on logarithmic data. When you engage SWR format, the analyzer performs the SWR conversion on the averaged data.

**AVG ON OFF** toggles the averaging function for the active channel on and off. The active entry area displays the averaging factor. The mode labels area displays the status symbol **A** for any channel with averaging turned on.

**RESTART AVERAGE** clears the averaged data and starts the averaging process to compute another set of averaged measurement data.

**AVG FACTOR** lets you select the averaging factor (shown in the active entry area) using the knob, STEP keys, or numeric keypad. Terminate the entry with the **ENT** key. At preset and power on, the analyzer defaults to an averaging factor of 8. You can set the averaging factor to 1, 2, 4, 8, 16, 32, 64, 128, or 256.

CAL — Calibration Menus

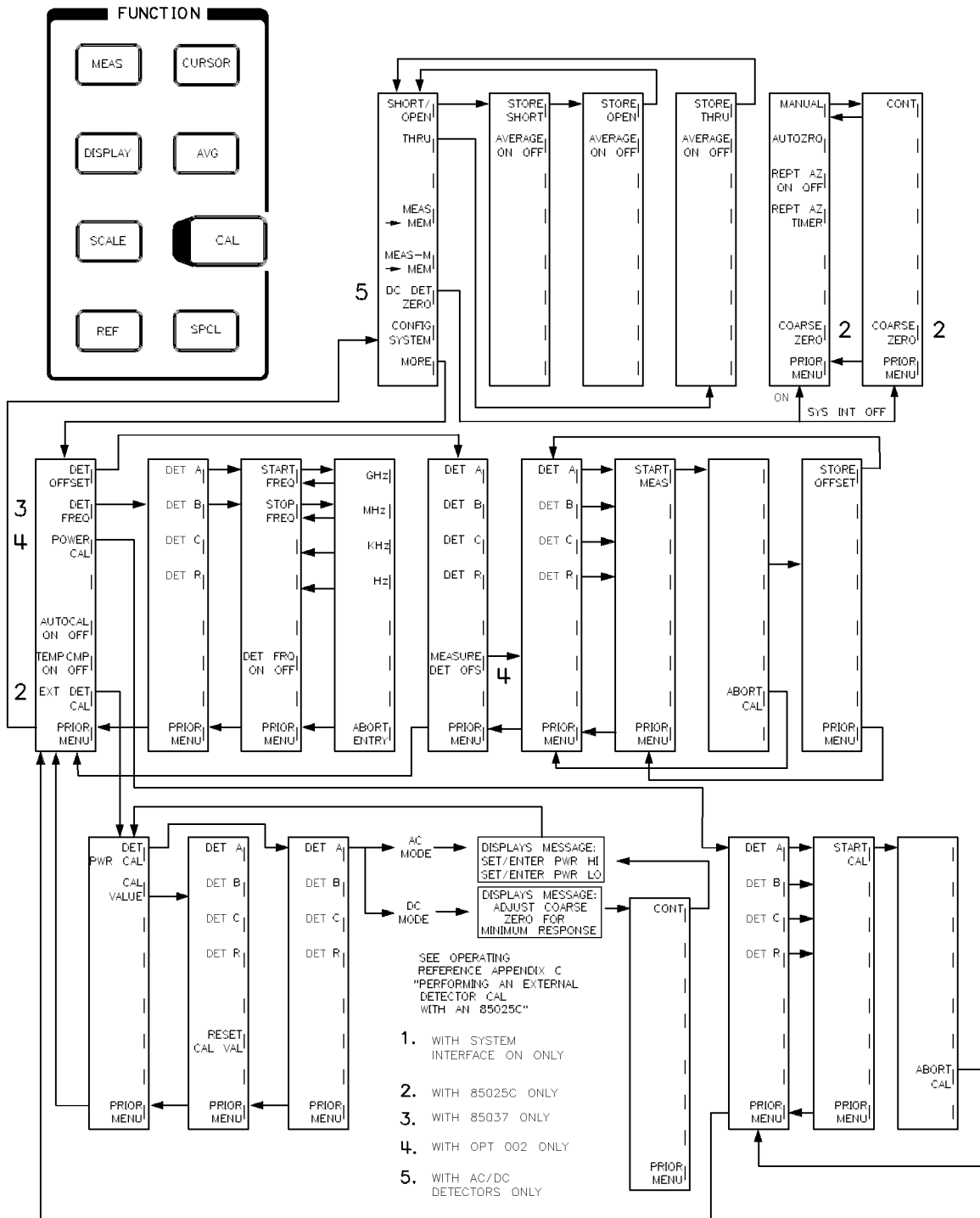

Figure 4-8. CAL Key and Calibration Menus

## CAL

The **CAL** key presents the calibration menus. The softkeys in this menu allow you to do the following activities:

- perform and store calibrations
- perform detector zero calibrations
- set detector offsets
- turn on automatic internal calibration

You can perform a calibration without changing the analyzer's display mode. The analyzer measures the calibration standards, stores the data at the highest resolution, and returns the display mode you previously set.

**SHORT/OPEN** prompts you through a short/open calibration. The analyzer stores this calibration in memory in dB/dBm format. When you select this softkey, the analyzer displays `CONNECT SHORT ... STORE WHEN READY`, turns averaging off, and presents a second menu layer.

**STORE SHORT** measures the short circuit response. Connect the short to the bridge test port, and select this softkey. The analyzer displays `CONNECT OPEN ... STORE WHEN READY`, turns averaging off, and presents a third menu layer.

**STORE OPEN** measures the open circuit response. Connect the open circuit to the bridge test port, and select this softkey. The analyzer averages the open and short calibration data, stores it in the active channel memory, and displays the first calibration menu. The analyzer displays `SHORT/OPEN CAL SAVED IN CH1 MEM` (the indicated channel depends on the active channel).

**AVERAGE ON OFF** toggles averaging on and off (the same averaging function engaged when you select averaging in the averaging menu). When you press **SHORT/OPEN** or **STORE SHORT**, the analyzer turns averaging off. Therefore, if you want the calibration to be averaged, select averaging on.

The averaging factor does not change from the value you previously set in the averaging menu. If you wish to change the averaging factor, you must return to the averaging menu.

**THRU** prompts you to make a thru calibration. The analyzer stores this calibration in dB/dBm format. When you select this softkey, the analyzer displays `CONNECT THRU ... STORE WHEN READY`, turns averaging off, and presents a second menu layer.

**STORE THRU** measures the thru response. Connect the thru in place of the device under test and select this softkey. The analyzer displays:  
`THRU SAVED IN CH1 MEM`, turns averaging off, and presents the first calibration menu.

If the analyzer is not in measurement-minus-memory mode, the analyzer displays `For Normalized Meas ... select [DISPLAY] [MEAS-MEM]`. Press these keys to normalize the measurement.

**AVERAGE ON OFF** toggles averaging on and off (the same averaging function engaged when you select averaging in the averaging menu). When you press **THRU** or **STORE THRU**, the analyzer turns averaging off. Therefore, if you want the stored calibration to be averaged, select averaging on.

The averaging factor does not change from the last value set in the averaging menu. If you wish to change the averaging factor, you must return to the averaging menu.

**MEAS—MEM** stores the current measured data into memory in dB/dBm format (even if you view the data in SWR format).

**MEAS-M—MEM** stores the measurement-minus-memory (normalized trace) into memory. You can use this function only for ratio measurements.

**DC DET ZERO** allows you to zero a DC detector, eliminating small DC voltages present in the detector, and establishing the noise floor with no RF signal applied. If your source is connected over a system interface, pressing **DC DET ZERO** presents another menu.

Otherwise, the analyzer presents the **CONT** key.

---

**Remember** Periodic zeroing is recommended for DC mode measurements. Zeroing of the detector is most important for lower level measurements.

---

This softkey appears in the calibration menu only when you connect an AC/DC detector or bridge to a detector input.

Zero a DC detector when you first connect it to the analyzer, *before* calibration, and whenever significant temperature changes occur.

**MANUAL** lets you manually remove the RF signal from the detectors. Use this method of zeroing when a small RF signal is present in the device under test (such as amplifiers, mixers, and oscillators).

---

**Note** Before pressing **CONT**, disconnect your DC detector from any RF signal, then select the manual method of zeroing.

---

**CONT** nulls any signal present at the detector input. The previous menu returns.

**COARSE ZERO** appears in this menu only if you connect an HP 85025C detector adapter to the analyzer. See Appendix C “Performing an External Calibration” in this manual, or refer to the HP 85025C detector adapter manual for instructions on this procedure. (This procedure, written for an HP 8757A, applies also to the HP 8757D.)

**AUTOZRO** turns off the RF signal from the source and automatically performs the DC detector zero. Use this method of zeroing in the following situations:

- when your source is connected to the analyzer through the 8757 system interface bus
- when your test device is NOT an active device; that is, an amplifier, mixer, or oscillator)

You can perform an autozero at any time, even with the repeat autozero function engaged. This softkey appears in this menu only if you connect a compatible source to the analyzer through the 8757 system interface.

**REPT AZ ON OFF** toggles a periodic autozero on and off. The analyzer is factory-set to an interval of 5 minutes.

## CAL

**REPT AZ TIMER** lets you change the interval between autozero repeats. Use the numeric keypad to set intervals from 1 to 60 minutes (terminate the entry with the **ENT** key). The interval does not change at preset or power on.

**COARSE ZERO** allows you to adjust the coarse zero for a minimum signal on the analyzer. See Appendix C “Performing an External Calibration” in this manual, or refer to the HP 85025C detector adapter manual for instructions on this procedure. (This procedure, written for an HP 8757A, applies also to the HP 8757D.)

This softkey appears in this menu only if you connect an HP 85025C detector adapter to the analyzer.

**CONFIG SYSTEM** forces the computation on the internal calibration tables for all detector inputs shown on the analyzer display. See “Self-Calibration” in this section for more information.

**MORE** Presents another menu that continues the calibration menu.

**DET OFFSET** lets you set an offset value in dB for each detector. For example, the difference between the power reading of an analyzer input and the power meter reading, or the value of an attenuator used with a detector.

**DET A**, **DET B**, **DET C**, and **DET R** let you select the detector to set an offset value. The active entry area displays the current offset value for that detector. Use the step keys, knob, or numeric keypad to change the offset, and terminate the entry with the **dBm/dB** or **ENT** key. The allowable range of entry values is +60 to -60 dB. The analyzer correctly displays the data in dBm, including the offset for absolute power measurements, or dB for ratio measurements.

A detector offset, valid during both calibration and measurement, remains in effect until you change it. An offset affects the detector *input*. Therefore, the offset applies to any measurement made on that input regardless of which channel selects the measurement. When you press **PRESET**, the analyzer resets all detector offset values to zero. But, if you cycle the instrument power, the detector offset values are not affected. Offsets are stored in the SAVE/RECALL registers.

**MEASURE DET OFS** appears when option 002 has been installed in your analyzer. This key allows you to measure a detector offset using the 50 MHz power calibrator. The offset may be measured at any level from +20 dBm to -50 dBm. This offset may then be stored as a detector offset, which is applied during all measurements made with this detector.

A message appears on the analyzer :

```
SELECT DETECTOR FOR DET OFFSET MEASUREMENT
A:AC\DC OFS B:AC\DC R:AC\DC
```

This message shows that you can select an input for measuring an offset for that detector. The message displays that input A has an offset entered for it, and that B and C do not. Also, that AC/DC type detectors (the 85025 or 85037 Series detectors) are connected to inputs A, B, and R.

**DET A**, **DET B**, **DET C**, **DET R** lets you select the detector input for the offset measurement. Connect the detector and attenuator (if used) between the detector input and the calibrator.

**START MEAS** starts the detector offset measurement and displays the results. You may set the test power for the detector offset when the **START MEAS** menu is displayed. The calibrator power level used in the measurement is displayed as:

```
CALIBRATOR POWER
+0 dBm
```

It is recommended that a calibrator power level be set near the power at which the detector is being used.

The analyzer performs the measurement in the currently selected detection mode, AC or DC.

If you had a 6 dB attenuator connected to the detector input, you would want to measure the actual attenuation. The result display might read:

```
Det Offset=6.230 dB
Calibrator Pwr= 0 dBm   Measured Pwr= -6.230 dBm
```

This means that the calibrator applied 0 dBm to the detector/attenuator and the HP 8757D measured this power as  $-6.230$  dBm. The absolute power measured depends on the pad attenuation and factors such as temperature drift in the detector, detector RF connector wear, and inherent accuracy limitations in the detector.

If an error message is displayed during this process, refer to “In Case of Difficulty” in the Error Messages section.

**ABORT CAL** aborts the measurement just started.

**STORE OFFSET** stores the measured detector offset that will be used later to remove this offset error from measurements.

---

### Note

You may want to connect an attenuator to the input of the detector when you are making measurements on a high power amplifier. For example, to reduce the RF power level below the detector maximum operating power level, or to reduce the power applied to the detector so harmonics in the test signal cause less power error in the measurement.

---

The **DET FREQ** softkey appears when you connect an HP 85037A/B detector to the analyzer. An HP 85037A/B detector assembly includes an EEPROM that contains correction constants for that particular detector operation over a range of frequencies. The correction constants provide the analyzer with an accurate detector frequency response. By pressing **DET FREQ**, you can set the start and stop frequencies to apply the detector frequency response correction for the particular measurement range.

This function could be helpful in a mixer measurement where the frequency you want the detector to measure is different from the source frequency. Refer to “Appendix D Mixer Measurements” for examples of mixer measurements.

**Note**

The frequency range you set after pressing **DET FREQ** affects both sweeps when the analyzer is in the alternate sweep mode. If you set the detector frequencies with channel 1 or 3 active, then the frequencies apply when channel 1 and 3 are swept. Likewise, if you set the detector frequencies with channel 2 or 4 active, the frequencies apply when channel 2 and 4 are swept.

However, you can set unique detector frequency sweep values for different measurement channels. For example:

Start = 1GHz, Stop = 11 GHz for the sweep on channels 1 and 3

Start = 3GHz, Stop = 13 GHz for the sweep on channels 2 and 4

---

**DET A**, **DET B**, **DET C**, **DET R** lets you select the detector for the entry of start and stop frequencies.

**START FREQ** and **STOP FREQ** allow the start and stop frequencies to be entered.

**DET FREQ ON/OFF** *must* be turned on for the start and stop frequencies to be activated, otherwise the analyzer will use the sweeper's start/stop frequencies.

The analyzer can display the current detector frequency settings if you enter the **CAL**, **MORE DET FREQ**, **DET A** menus (assuming that you selected detector A).

**POWER CAL** presents the power calibration menu. Connect the detector to be calibrated to **POWER CAL OUT**.

**DET A**, **DET B**, **DET C**, **DET R** lets you select the detector for the power cal.

**START CAL** starts the calibration. As the calibration proceeds, the analyzer displays the power level being measured. When the calibration is complete, the analyzer displays the measured range for each detector input.

**ABORT CAL** This key allows the user to prematurely stop a power calibration once it has been started. For example, when you started the calibration before connecting the detector.

By disconnecting a detector from the HP 8757D's input, you remove the calibration. When you reconnect the detector to the input, the analyzer uses the correction constants stored in the detector.

**Note**

To obtain the best accuracy, and to meet the "corrected" dynamic accuracy specifications, each detector must be characterized on the HP 8757D input where it will be used. The characterization routine simultaneously corrects both AC *and* DC measurements. This routine is also useful as an operator's check to ensure the detector is operating correctly. Only the HP 8757D with an option 002 power calibrator has this capability.

While only specified for the HP 85037 precision detector, the power calibrator also functions with and typically improves the accuracy of the HP 85025, 11664 detectors, HP 85025C external detector, and the HP 85027 bridge. This process improves the 50 MHz dynamic accuracy to the same accuracy as an HP 85037 specification.



**AUTOCAL ON OFF** gives you control over the automatic regeneration of the internal calibration tables for the detector inputs. Selecting this softkey toggles autocalibration on and off. See “Self-Calibration” for more details.

**TEMPCMP ON OFF** gives you control over the analyzer’s continuous temperature compensation. Selecting this softkey toggles temperature compensation on and off. See “Self-Calibration” for more details.

**EXT DET CAL** appears only if you connect an HP 85025C detector adapter to the analyzer. Use this function to calibrate the amplitude response for a Schottky diode detector.

**DET PWR CAL** activates a calibration sequence that consists of providing the analyzer with two known power levels. Once you perform a calibration with a detector, the analyzer retains the calibration.

**DET A**, **DET B**, **DET C**, **DET R** lets you select the input for the connected detectors.

**CAL VALUE** allows you to enter an HP 85025C detector calibration value on any analyzer input. See appendix C “Performing an External Detector Calibration” or the HP 85025C manual for instructions on this procedure (although written for an HP 8757A, it applies also to an HP 8757D).

**DET A**, **DET B**, **DET C**, **DET R** lets you select the detector.

**RESET CAL VALUE** allows you to reset the cal value to factory-set default value.

## Self-Calibration

The calibration menu softkeys **CONFIG SYSTEM**, **AUTOCAL ON OFF**, and **TEMPCMP ON OFF** relate to the analyzer’s internal calibration. With both autocalibration and temperature compensation on, the analyzer performs all internal calibration automatically, making it transparent to the user. The analyzer automatically maintains absolute and dynamic power accuracy for each detector input using two independent digital correction processes:

1. autocalibration — a regeneration of the internal calibration tables whenever:
  - you change the accessory configuration
  - a significant change in temperature occurs (approximately 5°C)
2. temperature compensation — a continuous compensation for small changes in temperature

You can control both of these correction processes in the second calibration menu. At preset or power-on, both autocalibration and temperature compensation are on, and the analyzer performs all internal calibrations automatically.

## Autocalibration

When you turn autocalibration on by selecting **AUTOCAL ON**, the analyzer automatically updates the internal calibration tables. Use autocalibration for most applications. The analyzer may update its internal calibrations tables under any of the following conditions:

With autocalibration on *or* off:

- at instrument preset, power-on, or recall instrument state
- **CONFIG SYSTEM** softkey selected

Only with autocalibration on:

- detector or bridge configuration changed
- large temperature change
- at a fixed 5-minute interval

To regenerate the calibration tables, the analyzer determines the following for each detector input:

- detector or bridge type (AC only or AC/DC)
- detector or bridge power versus voltage characteristics
- temperature of the detector (AC/DC accessories only) and the log amplifier

Using these readings, the analyzer automatically computes the internal calibration tables and the analyzer displays **CONFIG SYSTEM COMPLETED**. Depending on the configuration, the table regeneration process can take a few seconds.

In a thermally stable environment (temperature drift less than 5°C), thermal drift in the log amplifiers is minimal. The detectors, however, may be exposed to significant changes in temperature. Autocalibration automatically compensates for significant temperature changes.

## Temperature Compensation

When you turn temperature compensation on **TEMPCMP ON**, the analyzer performs continuous temperature compensation to the data. This corrects the measurement data for small drifts in temperature without the need to recompute the calibration tables.

Always use temperature compensation when you make measurements (this function turns on at preset and power-on). Turn off temperature compensation *only* when diagnosing a possible problem with the analyzer or its detectors.

## SPCL — Special Menus

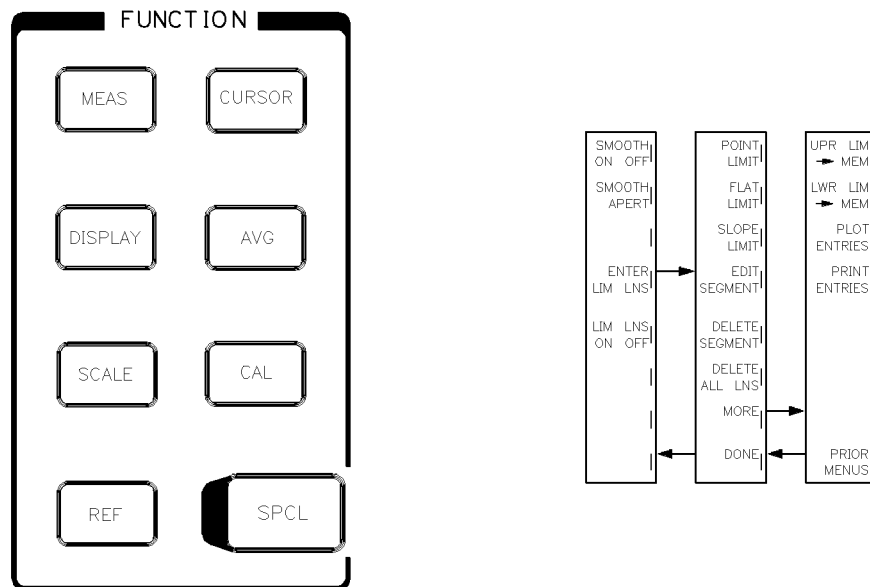

Figure 4-9. SPCL Key and Special Menu

**SMOOTH ON OFF** toggles the smoothing function (video filtering) on and off. Smoothing calculates a moving average of the active channel data. The aperture of the moving average is a percent of the sweep span, not greater than 20%.

Smoothing differs from averaging in that smoothing computes each data point based on one sweep, on the average of data points on both sides of that data point in the current sweep, while averaging computes each data point based on the average value of each point during several sweeps. The mode labels status symbols area displays an “S” for any channel with smoothing activated. Preset turns smoothing off for all channels.

**SMOOTH APERT** lets you change the value of the smoothing aperture. The aperture defaults to 5% at preset. Use the knob, STEP keys, or numeric keypad to change the smoothing aperture value. Enter any value from 0.1 through 20%.

**ENTER LIM LNS** presents the first of two limit lines menus. Using these softkeys, you can define limit lines for channel 1 and for channel 2. The limit lines consist of upper and lower limits for a frequency or a band of frequencies. You can also choose just the upper or the lower limit. After you activate the limit lines, the measurement data is compared to the displayed limit lines. The analyzer displays FAIL below the mode labels area for an out-of-limit condition. You can choose from three types of limit lines:

- point
- flat
- slope

## SPCL

A limit line can contain up to 12 segments; each segment can be any one of the three types. Segments entered from the front panel are numbered sequentially; those entered through HP-IB can be entered randomly. The analyzer prompts you for frequency, upper, and lower limits. Use the numeric keypad to enter the frequency, terminating the entry with the appropriate softkey: **x1**, **Hz**, **kHz**, **MHz**, **GHz**. Use the numeric keypad to enter the upper and lower limits, terminating the entry with the **dBm/dB** or **ENT** key. If you do not want either an upper or lower limit, press **dBm/dB** or **ENT** at the prompt. You can store limit lines *only* in save/recall registers 1 through 4. You can enter limits in dB, dBm, V (in AUX mode), or SWR, depending on the display format. In SWR mode, however, you cannot save the limits in trace memory.

**POINT LIMIT** lets you define a limit for a single frequency point.

**FLAT LIMIT** lets you define a flat limit (a constant value between two frequency points).

**SLOPE LIMIT** lets you define a sloped limit between two frequency points (linear with frequency).

**EDIT SEGMENT** lets you redefine an existing limit line segment. When you select this softkey, the analyzer prompts you for the number of the segment you wish to change. Use the numeric keypad to enter the segment number, then press **ENT**. The analyzer deletes the entire segment. Re-enter the segment. First choose the limit type from the softkeys. The analyzer then prompts you to enter frequencies and limit values.

**DELETE SEGMENT** lets you delete an entire limit line segment. The analyzer prompts you for the segment number to delete. Use the numeric keypad to enter the segment number and terminate the entry with the **ENT** key.

**DELETE ALL LNS** lets you delete all existing limit lines for that channel.

**UPR LIM—MEM** places the upper limit line into memory.

**LWR LIM—MEM** places the lower limit line into memory.

When you put either the upper or lower limit line into memory, the active channel memory is initialized with a 0 dB (or 0 dBm) reference level. The limits are then updated in memory in the order you entered the segments. (For overlapping limits, the last entry overwrites any overlap of the previous entry, and points with no limit data entered as 0 dB or 0 dBm.) You cannot use the limit-line-to-memory functions with SWR display mode.

**PLOT ENTRIES** sends the limit line frequency and amplitude values to the plotter (in tabular format).

**PRINT ENTRIES** sends the limit line frequency and amplitude values to the printer (in tabular form).

**DONE** terminates limit line data entry for the active channel. It also returns the special functions menu.

**LIM LINS ON OFF** toggles the limit lines on and off for the active channel. When you turn limit lines on, each limit line segment becomes visible on the analyzer as you enter it. You can turn limit lines on, even without entering limit lines. In this case, the analyzer displays **PASS** for any measurement data.

## INSTRUMENT STATE

---

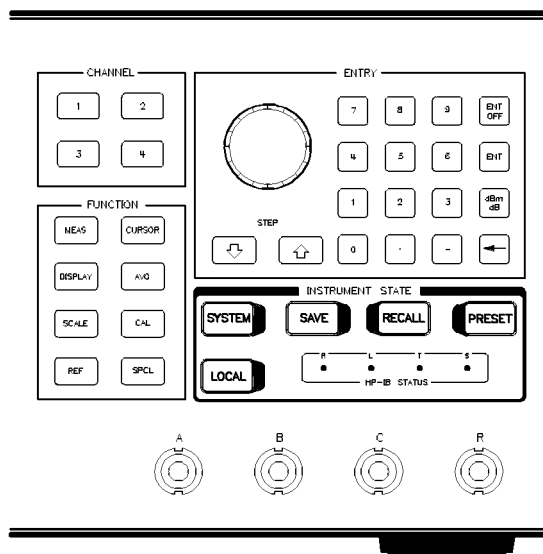

**Figure 5-1. Instrument State Keys**

Use the INSTRUMENT STATE keys (Figure 5-1) to control system functions that are not channel-specific but apply to the entire instrument state.

SYSTEM — System Menus

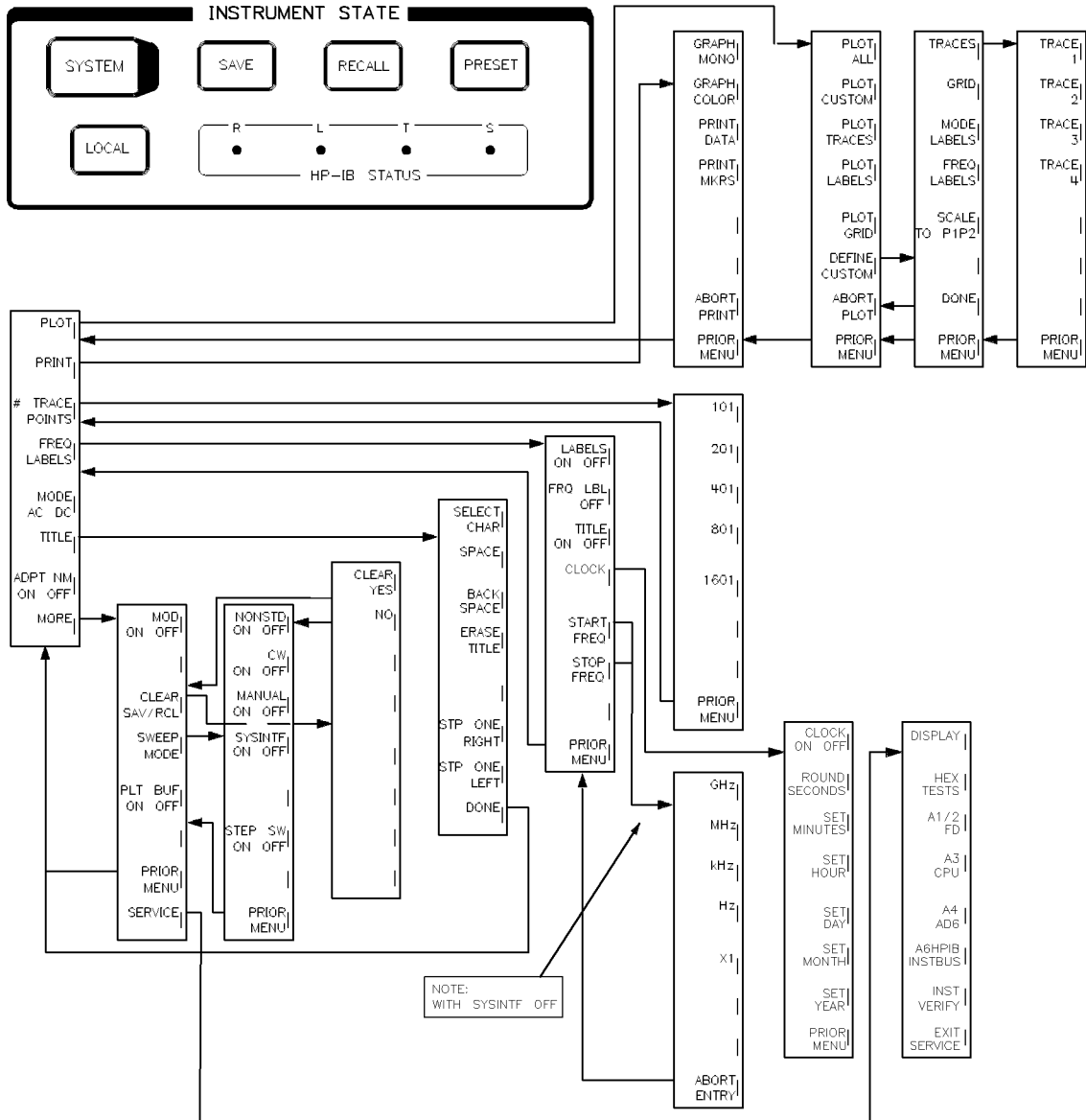

Figure 5-2. SYSTEM Key and System Menus

The SYSTEM key presents the system menus, providing a variety of softkey functions that apply to the entire instrument state (such as plotting, printing, AC and DC detection mode, number of trace points, clock, and service).

**PLOT** presents the first of four plot menus that allow you to custom-define and initiate plots on a plotter on the HP 8757 system interface.

When you select a plot softkey, the analyzer freezes the displayed measurement and sends the data through a buffer.

Once the data is at the buffer, the analyzer can continue making measurements while the plotter makes a hardcopy.

The analyzer expects to find the plotter at HP-IB address 5, unless you set a different address (see **LOCAL**). If you set the plotter address incorrectly, or do not connect it to the 8757 SYSTEM INTERFACE, the analyzer displays **PLOTTER NOT AVAIL**. Correct the problem and press **PLOT** again to start generating the hardcopy.

If you do not load any paper, the analyzer displays **PLOTTER NOT READY**. Correct the problem and press **PLOT** again to start generating the hardcopy.

**PLOT ALL** causes the plotter to draw the grid, labels, trace data, cursor, markers, title, date, time, and (when turned on) limit lines and pass/fail indicators. Any message displayed in the active entry area also plots. (Press **ENT OFF** before plotting if you do not want the message to appear.) Plots do not include status line information.

**PLOT CUSTOM** causes the plotter to draw a plot using only the attributes specified with the **DEFINE CUSTOM** softkey in this menu.

**PLOT TRACES** draws the trace data for all the channels turned on. The traces include cursors, cursor deltas, and markers. And if the functions are turned on, the traces also include limit lines, pass/fail indicators, and a date/time stamp.

**PLOT LABELS** draws the mode labels, reference line position labels, and frequency labels (when turned on).

**PLOT GRID** draws the horizontal and vertical graticule lines.

**DEFINE CUSTOM** lets you specify which plot attribute or combination of attributes to include in a custom-defined plot format. The format you define is reflected in the hardcopy when you press **PLOT CUSTOM**. The analyzer highlights the softkey labels for the attributes you select to plot.

**TRACES** lets you specify the trace or traces that the plotter draws on the hardcopy (traces 1-4). Each trace softkey toggles on and off. You can only plot traces of channels that are turned on (**TRACE 1**, **TRACE 2**, **TRACE 3**, **TRACE 4**).

**GRID** includes the horizontal and vertical graticule lines in the custom plot format.

**MODE LABELS** includes the mode labels in the custom plot format.

**FREQ LABELS** includes the frequency label information in the custom plot format (unless you turn them off by pressing **LABELS OFF** or **FRQ LBL OFF**). The label information includes the sweep frequencies and cursor frequency.

**SCALE TO P1P2** expands the plot to place the lower left corner of the grid at the plotter's P1 position, and the upper right corner of the grid at the plotter's P2 position.

## SYSTEM

**DONE** terminates the custom plot format definition and displays the prior plot menu.

**ABORT PLOT** terminates the plotting of a hardcopy. The plotting does not stop immediately; it stops after the buffer empties.

**PRINT** presents menus that allow you to select printing options.

When you select a print softkey, the analyzer freezes the displayed measurement and sends the data through a buffer. Once the data is at the buffer, the analyzer can continue making measurements while the printer generates a hardcopy.

The analyzer expects to find the printer at HP-IB address 5, unless you set a different address (see **LOCAL**). If you set the address of the printer incorrectly, or do not connect it to the 8757 SYSTEM INTERFACE, the analyzer displays **PRINTER NOT AVAIL**. Correct the problem and then select the print softkey again to begin printing.

If you connect the printer correctly but do not load any paper the analyzer displays **PRINTER NOT READY**. Correct the problem and then select the print softkey again to begin printing.

**GRAPH MONO** causes the monochrome printer to draw the grid, labels, trace data, cursors, markers, date, time, and title. Messages in the active entry area and most softkeys are not included.

**GRAPH COLOR** causes the color (HP PaintJet) printer to draw the grid, labels, trace data, cursors, markers, date, time, and title. Messages in the active entry area are not included. The printer prints with a default set of colors that approximate the analyzer default colors with white and black reversed. You cannot change the fixed printer default colors.

Both mono and color prints include limit lines and pass/fail indicators.

Graphics written to the analyzer display through the HP-IB are not drawn by the printer. You can access the printer with passthrough commands (described in “Remote Operation”).

**PRINT DATA** causes the printer to list all data in tabular form (Table 5-1).

**Table 5-1. Example Printout for PRINT DATA**

No.	Frequency (Hz)	Chan. 1 (dBm)	Chan. 2 (dBm)
0	1E+07	-3.391	-57.017
1	2.4975E+07	-3.187	-55.555
2	3.995E+07	-3.127	-53.998
3	5.492E+07	-3.141	-59.741
4	6.99E+07	-3.176	-56.984
5	8.487501E+07	-3.215	-54.775
6	9.985003E+07	-3.248	-59.370
7	1.14825E+08	-3.248	-54.759
8	1.298E+08	-3.196	-55.099
9	1.44775E+08	-3.122	-57.909
10	1.5975E+08	-3.058	-58.939
11	1.74725E+08	-2.998	-54.855
12	1.897E+08	-2.970	-53.866
13	1.046751E+08	-3.006	-55.844
14	2.1965E+08	-3.039	-59.211



**PRINT MKRS** signals the printer to generate a listing of the frequency and amplitude values of the source markers that you have activated. The cursor amplitude value and frequency also print if you turn the cursor on (see Table 5-2).

**Table 5-2. Example Printout for PRINT MKRS**

Markers			
No.	Frequency (Hz)	Chan. 1 (dBm)	Chan. 2 (dBm)
1	2.930125E+09	-12.122	+2.570
2	3.798676E+09	-12.207	+1.894
3	2.211325E+09	-14.600	+2.886
Cursors			
1	1.971725E+09	-14.548	+2.701
d	2.06655E+09	+4.370	+ .514

If you are using the alternate sweep mode, the printouts include the channel pair with the active channel (channels 1 and 3 or channels 2 and 4). To print the other pair, activate one of the channels in that pair and print again.

**ABORT PRINT** terminates the printing of a hardcopy. The printing does not stop immediately; it stops after the buffer empties.

**# TRACE POINTS** lets you choose the number of data points that the analyzer uses to process and display the measurement. If you select fewer points, the analyzer will have lower resolution, but you can set faster sweep times. You can select a maximum of points (for each trace) depending on the number of traces you have displayed on the analyzer:

- 401 trace points for up to four traces displayed
- 801 trace points for up to two traces displayed
- 1601 trace points for only one trace displayed

The number of points you selected does not change at power on. However, at instrument preset, the analyzer defaults to 401 points.

**FREQ LABELS** allows you to access the screen labels, frequency labels, clock, and title functions.

**LABELS ON OFF** toggles the mode labels, the frequency labels, and the analyzer display status line on and off.

If you activate any limit lines, the pass/fail indicator is not blanked until you disable the limit lines.

**FRQ LBL OFF** turns off the frequency labels, and blanks the source frequency readout. If you press this softkey, the frequency labels information will not get plotted or printed. You can restore the frequency labels by presetting the analyzer, but this also resets the frequency information to preset conditions.

## SYSTEM

Even if you have the frequency labels off when you save or store an instrument state, the complete source instrument state information is included. However, when you recall the instrument state, the frequency labels are off, reflecting the state that you have saved. See **CLEAR SAV/RCL** for additional information.

HP-IB programming commands also let you turn the frequency labels off so you can operate the analyzer in the secure frequency mode. See “Secure Frequency Mode” in any of the remote operation documents.

**TITLE ON OFF** toggles the titles on and off without erasing the title.

**CLOCK** allows you to set the time and date so they appear on measurement prints and plots.

**CLOCK ON OFF** toggles the time and date function on and off. If the clock function is on, the date and time will be displayed on the analyzer and will also appear on any measurement prints or plots.

**ROUND SECONDS** sets the seconds of the analyzer clock to zero. The function also rounds the seconds to the nearest minute.

**SET MINUTES** allows you to set the minutes for the analyzer clock. Your entry must be terminated by pressing **ENT**.

**SET HOUR** allows you to set the hour for the analyzer clock. Your entry must be terminated by pressing **ENT**.

**SET DAY** allows you to set the day of the month for the analyzer clock. Your entry must be terminated by pressing **ENT**.

**SET MONTH** allows you to set the month of the year for the analyzer clock. Your entry must be terminated by pressing **ENT**.

**SET YEAR** allows you to set the year for the analyzer clock. Your entry must be terminated by pressing **ENT**.

**START FREQ** lets you specify the start frequency value that will appear at the left graticule. You can use this function only with the system interface off or without a source HP-IB connection. After you select **START FREQ**, enter the start frequency with the numeric keypad and terminate the entry with the appropriate units softkey (such as **GHz** or **MHz**).

**STOP FREQ** lets you specify the stop frequency value that will appear at the right graticule. You can use this function only with the system interface off or without a source HP-IB connection. Engage this function the same way as **START FREQ**.

---

### Note

The frequency labels are useful if you are making a swept measurement without an HP-IB sweeper, or with the system interface off.

---

**MODE AC DC** toggles between AC and DC detection modes. If you connect a source to the system interface, the analyzer automatically controls the source modulation (normally on for AC and off for DC).

**TITLE** allows you to define a title that can appear on the analyzer display and on a hardcopy. You select each character of the title from the active entry area. The characters consist of the letters of the alphabet, the digits 0 through 9, a decimal point, and the mathematical symbols ( ) + - / . = :.

**SELECT CHAR** enters a character you selected to be included in the title. Turn the knob or repeatedly press the **STP ONE RIGHT** or **STP ONE LEFT** softkey until the arrow points to the character you want. Press **SELECT CHAR** and the character appears in the title.

**SPACE** inserts a blank space next to the last character you entered for the title.

**BACK SPACE** deletes the last character you entered for the title.

**ERASE TITLE** deletes the entire title you just entered.

**STP ONE RIGHT** moves the arrow pointer to the next character on the right.

**STP ONE LEFT** moves the arrow pointer to the next character on the left.

**DONE** terminates the title entry and displays the system menu.

**ADPT NM ON OFF** toggles adaptive normalization on and off. Adaptive normalization interpolates the calibration data stored in the analyzer memory when you reduce the frequency span or change the number of points. This feature allows you to display a portion of the calibrated frequency range without recalibrating. The resolution of the narrower range does not change as you expand the trace. Do not use adaptive normalization if the device response varies greatly with frequency.

An asterisk appears in the status symbols area for any channel with adaptive normalization engaged. If you expand the frequency range beyond the calibrated range, the analyzer extrapolates the calibration data outside that original frequency span as a straight line. In this case, a U appears in the status symbols area.

**MORE** displays the continued portion of the system menu.

**MOD ON OFF** toggles the analyzer rear panel modulation output on and off. You can use this softkey to override the analyzer's automatic switching of the modulation on in AC detection mode and off in the DC detection mode.

**CLEAR SAV/RCL** clears all of the save/recall registers and presets both the analyzer and a connected compatible source. When you press this softkey, the analyzer displays IF YOU WANT TO CLEAR ALL REGISTERS, PRESS YES, and displays a menu where you can choose to clear the storage registers.

**CLEAR YES** clears all the analyzer save/recall registers and returns the channel menu to the instrument preset state.

**NO** displays the prior system menu with all of the save/recall registers contents intact.

**Note**

If you are working in a high-security environment, you can configure the analyzer to clear all save/recall registers each time you switch off the instrument power. You can enable this function as follows:

1. Remove the battery (A3BT1) from the A3 CPU board. This prevents storage of any register data. The internal self test now indicates a battery failure at power up.
2. Install a wire jumper (A3W2) on the A3 CPU board, just below U2. This jumper signals the CPU to skip the battery self-test so the analyzer can resume normal operation. The analyzer briefly displays a warning message at each power cycle: **SAVE/RECALL registers defaulted**.

By removing the battery, you only affect the save/recall registers, not the analyzer's internal calibration.

---

**SWEEP MODE** presents a menu that allows you to specify the type of sweep supplied by a source that is not compatible with the HP 8757 system interface.

**NONSTD ON OFF** enables the analyzer to track a sweep ramp other than the typical 0 to 10 volt ramp. The nonstandard sweep should be within the 0 to 10 volt range or you must modify the A4 ADC assembly (see the service manual for instructions). See Product Note 8757-5 for a more detailed description of this mode.

To use the nonstandard sweep mode, disconnect the POS Z BLANK, the STOP SWEEP, and the 8757 SYSTEM INTERFACE connections to the source. You must have the SWEEP IN connected between the analyzer and source. The number of trace points you selected still applies in the nonstandard sweep mode.

**CW ON OFF** allows you to use a source that is incompatible with the HP 8757 system interface. With **CW ON**, the analyzer continuously updates the display when you set the source to CW. If you use a source that is compatible with the HP 8757 system interface, the analyzer selects this function automatically when you set the source to a CW mode.

**MANUAL ON OFF** toggles the manual sweep control on and off. With the analyzer manual function on, you can manually sweep the frequency range from the source. This function also allows you to use a manual sweep input signal from a source that is not compatible with the HP 8757 system interface.

**SYSINTF ON OFF** toggles the analyzer's control of the HP 8757 system interface on and off. With the analyzer's control OFF, another instrument on the HP 8757 system interface can control the instruments connected to the interface.

Instrument preset does not change the setting of this function. When the analyzer's control is off, the analyzer status line displays **SYS INTF OFF**.

**STEP SW ON OFF** (available only with an HP 8340, 8360, or 83750 Series sources) toggles the step-sweep mode on and off. If you are using the step-sweep mode you must connect the source to the HP 8757 system interface.

**PLT BUF ON OFF** turns the plotter buffer on and off. If you select a plot softkey with the buffer on, the analyzer will continue measuring a device response while the plotter makes a hardcopy. However, not *all* active functions are available during a plot. If the buffer is off, the analyzer disables all active functions until a plot is finished. The analyzer is sent from the factory with the plotting buffer on. If you want the fastest plotting process, set the buffer off.

**SERVICE** displays the service menu, which allows you choose from a series of automated tests that check various analyzer functional blocks.

**DISPLAY** allows you to view test patterns, verify the A14 circuitry, and adjust various CRT display intensity levels.

**HEX TESTS** checks many different parts of the instrument with read/write and rotate tests. The CPU is instructed to access a user specified memory or I/O address and read or write data from or to that address, or write a rotating 1 data pattern.

These tests use the hexadecimal (hex) numbering system: Hex digits from 0 to 9 and A to F represent decimal numbers from 0 to 15. Each hex digit represents four binary digits or bits. An address is specified by six hex digits, while a data word is specified by four hex digits.

**A1/2 FP** presents a menu of tests the check the front panel knob, keys, and annunciators. In some cases, you can prompt the analyzer to force a diagnostic test even if the front panel is not working.

**A3 CPU** helps troubleshoot the A3 CPU assembly by accessing tests that check the RAM, programmable timer, EEROM, and the read function.

**A4 ADC** helps to troubleshoot the A4 analog-to-digital converter assembly by accessing tests that check the analog to digital signal converters, digital to analog signal converters, detector control circuitry, and sweep operation.

**HP-IB TESTS** helps to troubleshoot the A6 HP-IB assembly by checking HP-IB listen and talk modes.

**INST VERIFY** performs nine major instrument self-checks.

**EXIT SERVICE** returns to normal operation by initiating an instrument preset.

LOCAL

## LOCAL — Local Menu

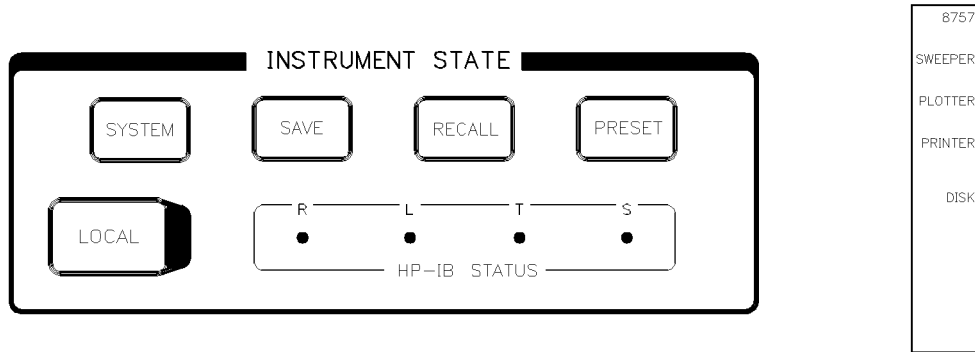

Figure 5-3. LOCAL Key and Local Menu

The LOCAL key returns the analyzer to local operation from the remote operation state unless a LOCAL LOCKOUT command has been received over HP-IB. The local menu lets you set HP-IB addresses for the analyzer and other instruments connected to the HP 8757 system interface. Table 5-3 lists the default addresses for these instruments.

Table 5-3. HP-IB Default Addresses

Instrument	HP-IB Address
8757	16
Sweeper	19
Plotter	05
Printer	01
Disk Drive	00

### Changing a Default Address

Do not set two instruments to the same HP-IB address. To change a default address:

1. Select the softkey for the instrument you wish to change. The analyzer displays the current HP-IB address.
2. Use the numeric keypad to enter a new address (0 through 29), and terminate the entry with the ENT key. The analyzer shows the new HP-IB address and stores it in memory.

Be sure that the address you set for each instrument matches the address physically set on the instrument.

SAVE — Save Menus

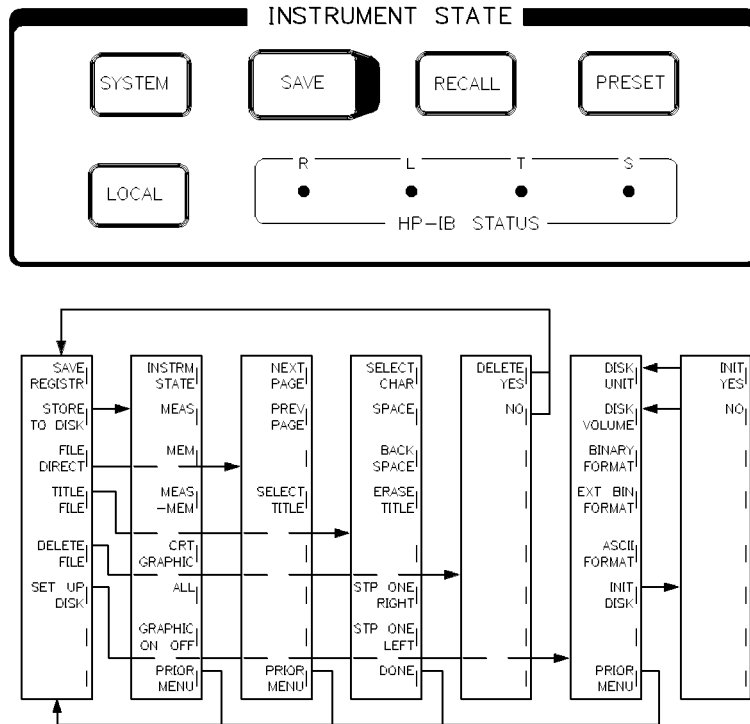

Figure 5-4. **SAVE** Key and Save Menu

The **SAVE** key allows you to save the current instrument state in the analyzer's save/recall registers (non-volatile memory) or to store the instrument states, measurement data, data in memory, and display graphics to a disk.

**SAVE**

**SAVE REGISTR** saves the current instrument state in a storage register. The active entry area displays **SAVE REG**. Using the numeric keypad, you can enter the number of the register where you wish to store the current instrument state (no terminating key is needed).

You can store nine different settings in registers 1 through 9. The information saved in a storage register depends on the register number used and on the channel number. All registers save the analyzer front panel settings and the source front panel settings (if it is compatible). Registers 1 through 4 also save titles. If channels 1 or 2 are saved in registers 1 through 4, limit lines and memory trace data are also saved. The saved memory trace has 401 data points regardless of the number of points you selected for the measurement.

You can recall saved information from a designated register unless you write over the register contents, or clear the contents with the **CLEAR SAV/RCL** softkey.

---

**Note** You can also save the current instrument state in a register by pressing **SAVE**, entering the number of the storage register.

---

**STORE TO DISK** presents a menu that lets you store instrument state, trace data, memory data, and display graphics to disk. You can create a unique file title to identify the information you store. If you don't create a file title, the analyzer will assign the stored information a default file title (for example: FILE1). Refer to the figure below.

If you store the instrument states for an analyzer and source combination, and then load the states into an analyzer with a different source, the original instrument states will apply to the new source. Table 5-4 lists the source settings saved on disk.

**Table 5-4. Source Settings Saved on Disk**

- |  |
|--|
| <ul style="list-style-type: none"><li>• ALC mode (internal, external, power meter)</li><li>• CF/<math>\Delta</math>F frequencies</li><li>• CW frequency</li><li>• display multiplier</li><li>• display offset (HP 8350B only)</li><li>• display update on/off</li><li>• marker delta</li><li>• marker sweep</li><li>• markers 1 through 5</li><li>• power slope</li><li>• power sweep</li><li>• RF power (on/off, value)</li><li>• square wave modulation on/off (HP 8350B only)<br/>or shift pulse modulation on/off (HP 8340/41/60)<br/>or scalar pulse modulation on/off (HP 83750)</li><li>• start/stop frequencies</li><li>• sweep mode (start/stop, CF/<math>\Delta</math>F, CW, swept CW)</li><li>• sweep time</li><li>• sweep trigger (internal, line, external)</li><li>• sweep type (manual, external, continuous)</li></ul> |
|--|



---

**Note** External disk drives for the HP/Agilent 8757D are no longer available from Agilent.

---

**Notes** You cannot save alternate state information or HP 8360 and 83750 Series user flatness data to disk.

Before you store anything to a new disk, you must initialize the disk. You must also identify the disk unit where the disk resides, and the disk volume number of a hard disk drive (see **SET UP DISK**).

---

**INSTRM STATE** stores the analyzer and source front panel settings to disk. The stored information is assigned the file title that is shown on the analyzer. If the stored instrument state data already exists under this file title, the analyzer writes the new data over the old data. You can create a new title by pressing **TITLE FILE** in the save menu.

**MEAS** stores the trace measurement data to disk. The displayed title will be assigned to the data file unless you create a new file title.

**MEM** stores the trace memory data to disk. The displayed title will be assigned to the data file unless you create a new file title.

**MEAS-MEM** Stores normalized trace data to disk. The displayed title will be assigned to the data file unless you create a new file title.

**CRT GRAPHIC** stores current analyzer graphics to disk. The displayed title will be assigned to the data file unless you create a new file title.

**ALL** stores the instrument state, trace measurement, normalized trace, memory, and analyzer graphics to disk in one operation. This information is stored in separate files under the active file title.

---

**Note** When accessing stored data from a computer's disk drive, you will see that the filename is a combination of the file title displayed in the HP 8757 directory list plus a two letter suffix. The following list shows the list of possible file title suffixes and the corresponding definitions:

IS - instrument state

Dx - data for channel x

Mx - memory for channel x

Nx - normalized (MEAS-MEM)

CG - CRT graphics

x = 1, 2, 3, or 4

For example, the disk file "FILE1N3" contains MEAS-MEM for channel 3 and would be listed as FILE 1 normalization on the HP 8757 file directory.

---

**SAVE**

**GRAPHIC ON OFF** toggles recalled graphics on and off. When this function is activated, the analyzer only shows graphics and softkey menus. (This key only appears if the display list contains a user generated display graphic.)

An example of how you might use this function is when you want to access an instrument connection diagram at any time during a measurement process.

**GRAPHIC OFF** turns off the graphics and returns the instrument state and measurement data.



**FILE DIRECT** shows you the directory of files on the specified disk. The directory can contain up to 382 files, with 16 files to a page.

<u>FILE</u>	<u>TITLE</u>	<u>DESCRIPTION</u>				<u>CREATED</u>			
➔ FILE1		Bin	Instr	State					29 Jan 93 14:08
FILE1		ASC	Meas	CH 1	101				29 Jan 93 14:08
FILE1		ASC	Memory	CH 1	101				29 Jan 93 14:08
FILE1		ASC	Nrmlyz	CH 1	101				29 Jan 93 14:08
FILE2		Bin	Instr	State					29 Jan 93 14:08
FILE2		ASC	Meas	CH 1	201				29 Jan 93 14:08
FILE2		ASC	Memory	CH 1	201				29 Jan 93 14:08
FILE2		ASC	Nrmlyz	CH 1	201				29 Jan 93 14:08
FILE2		ASC	Meas	CH 2	201				29 Jan 93 14:08
FILE2		ASC	Memory	CH 2	201				29 Jan 93 14:08
FILE2		ASC	Nrmlyz	CH 2	201				29 Jan 93 14:08
FILE3		Bin	Instr	State					29 Jan 93 14:08
FILE3		ASC	Meas	CH 1	401				29 Jan 93 14:08
FILE3		ASC	Memory	CH 1	401				29 Jan 93 14:08
FILE3		ASC	Nrmlyz	CH 1	401				29 Jan 93 14:08
FILE3		ASC	Meas	CH 2	401				29 Jan 93 14:08

**Figure 5-5. Directory of Stored Files**

**NEXT PAGE** shows you successive pages of the directory.

**PREV PAGE** shows you previous pages of the directory.

**SELECT TITLE** lets you select the active file title. The active file title appears at the top of the analyzer display. To select a file title, use the analyzer knob, or   keys to scroll through the directory and point to your title choice. Press **SELECT TITLE** to make your title selection.

**TITLE FILE** lets you create a new file title. The title area displays the current active file title. To create a new file title, first erase the active file title. Then enter up to eight characters. The title area shows the new title as you create it.

**SELECT CHAR** enters your character selection. Turn the analyzer knob to point to your character choice. Press **SELECT CHAR** and the character will appear in the title area.

**SPACE** enters a space character in your title.

**BACK SPACE** deletes the last character entered in the title.

**ERASE TITLE** deletes the entire title.

**STP ONE RIGHT** moves the arrow pointer to the next character to the right.

**STP ONE LEFT** moves the arrow pointer to the next character to the left.

**DONE** terminates entry of the title and returns the previous menu.

**DELETE FILE** deletes all the files from the directory that have the same file title. For example, FILE1. Selecting **DELETE FILE** shows you the active file title. Make sure that the files you wish to delete are active.

**DELETE YES** deletes all files in the directory with the active file title. If you wish to delete the files with the active file titles, press **DELETE YES**.

**NO** exits the delete file menu without deleting any files. If you want to delete files other than the current active file, use **SELECT TITLE** or the file directory to change the active file title.

**SET UP DISK** presents another menu that lets you set the disk unit and volume numbers, initialize disks, and define the format.

**DISK UNIT** shows the unit of the disk drive where the analyzer expects to find your disk. When you select **DISK UNIT**, **DISK UNIT** appears in the analyzer active entry area, along with the unit number of the drive.

To change the unit number, use the numeric keypad to enter the new unit number and terminate the entry with the **ENT** key.

**DISK VOLUME** shows you which volume of the disk drive the analyzer will access to save and recall data. When you select this softkey, **DISK VOLUME** appears in the analyzer active entry area, along with the drive volume number. The correct volume number is critical when using a hard disk. To change the volume number, use the numeric keypad to enter the new volume number and terminate the entry with the **ENT** key.

**BINARY FORMAT** sets the measurement and memory data format to binary. Binary format provides the fastest transfer speed of data, includes the detector offset, and uses the smallest storage space of the two formats available (binary and ASCII). The analyzer highlights and underlines the chosen format, and presets to binary format.

## SAVE

**EXT BIN FORMAT** sets the measurement and memory data format to binary. Binary format provides the fastest transfer speed of data, and uses the smallest storage space of the two formats available (binary and ASCII). The analyzer highlights and underlines the chosen format, and presets to binary format.

**ASCII FORMAT** sets the measurement and memory data format to CITT file format which is a version of an ASCII format. This format makes the stored data compatible with other computers.

**INIT DISK** lets you initialize a disk. The analyzer initializes the disk identified by **DISK UNIT** and **DISK VOLUME**. Be certain these are correctly set before continuing.

**INIT YES** begins the initialization. When the initialization process is complete, the message **WAITING FOR DISK** disappears from the analyzer display and the disk drive light turns off.

---

### Notes

It can take up to 30 minutes to initialize a hard disk.

For a write-protected disk, the analyzer displays **WARNING: DISK IS WRITE PROTECTED** and the initialization process aborts. If you still wish to initialize the disk, remove the write protection and select **INIT DISK INIT YES**.

---

**NO** displays the previous menu without running the initialization. It does *not* abort an initialization already in progress.

RECALL — Recall Menus

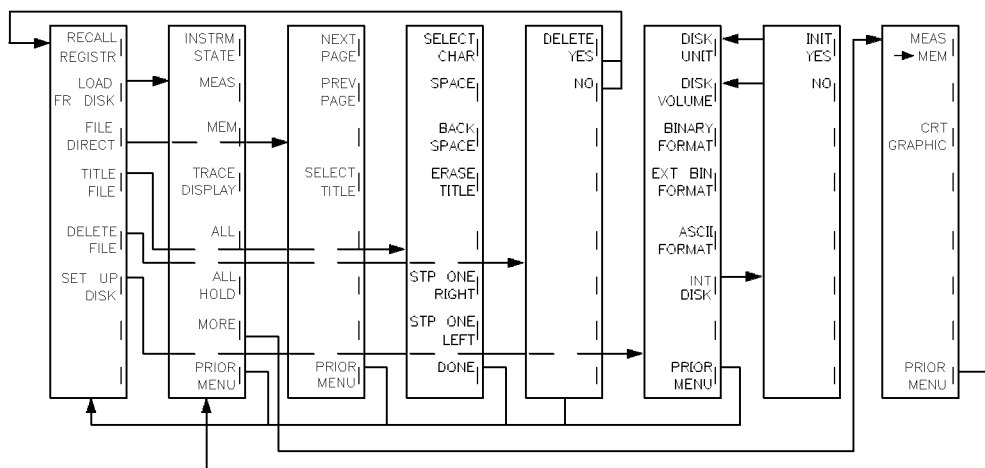
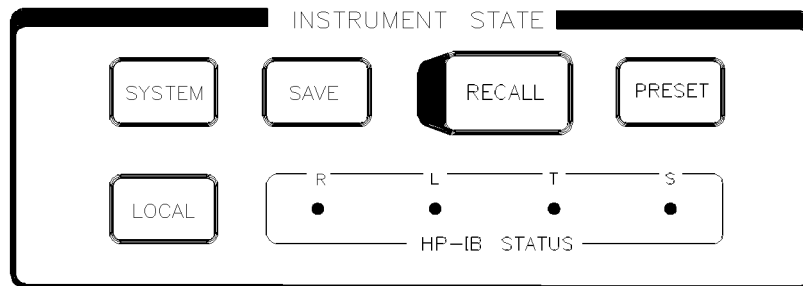

Figure 5-6. RECALL Key and Recall Menus

RECALL accesses function that allow you to recall information previously saved in the analyzer registers or on a disk.

RECALL REGISTR allows you to recall information saved in an analyzer storage register. Use the numeric keypad to enter the number of the register that contains the information you wish to recall (no terminator required). The analyzer retrieves the information saved in that register, then COMPLETE appears in the active entry area.

LOAD FR DISK presents a menu that lets you load the instrument state, trace data, and analyzer graphics from disk. The active file title (in the title area) identifies the file to load. If you want to load information from a different file, press PRIOR MENU FILE DIRECT and select the file title of the desired file. Then press LOAD FR DISK again.

## RECALL

**INSTRM STATE** loads instrument front panel settings from disk. This information must have been previously stored under the current active file title.

**MEAS** loads the measurement data from the disk into the measurement array for each channel that has a file with the Dx suffix, where x is the channel number. The analyzer holds the trace, which means that the measurement data is no longer updated until you turn **DISPLAY - HOLD** off. You can use the display, scale, ref, spcl - smooth, and cursor functions to display this data. A printer or plotter can generate a hardcopy of the displayed trace.

**MEM** loads trace memory data that was stored on disk. This information must have been previously stored under the current active file title.

**TRACE DISPLAY** loads the trace data from the disk into the trace array for each channel that has a file with the Nx suffix, where x is the channel number. The analyzer holds the trace, which means that the measurement data is no longer updated until you turn **DISPLAY - HOLD** off. You can use the scale, ref, and cursor functions to display this data. A printer or plotter can generate a hardcopy of the displayed trace.

**ALL** loads the instrument state, trace measurement and memory, and display graphics from disk in one operation. This information must have been previously stored under the current active file title.

**ALL HOLD** loads the instrument state (IS suffix), measurement data (Dx suffix), and/or the trace data (Nx suffix) from the disk. If the instrument state file and at least one of the two data files are found, then the measurement data is no longer updated until you turn **DISPLAY - HOLD** off. If trace data is loaded, you can view the data with the scale, ref, and cursor functions. If measurement data is loaded, you can view the data with the display, scale, ref, spcl - smooth, and cursor functions. A printer or plotter can generate a hardcopy of the displayed trace.

---

**Note** If the stored file has smoothed data, smoothing turns off.

---

**MEAS→MEM** loads trace measurement data from disk into the analyzer trace memory. This information must have been previously stored under the current active file title.

**CRT GRAPHICS** loads CRT graphics from disk. This information must have been previously stored under the current active file title.

**FILE DIRECT** shows you the directory of files on the specified disk. The directory holds 382 files, with 16 files to a page.

**NEXT PAGE** shows you successive pages of the directory.

**PREV PAGE** shows you previous pages of the directory.

**SELECT TITLE** lets you select a file title to be the active file title. The current active file title appears at the top of the CRT. Use the analyzer knob to move the arrow to the file title you wish to be the active file title. Press **SELECT TITLE**.

**TITLE FILE** allows you to define a new file title. The current active file title appears in the CRT title area. To create a new file title, first erase the active file title. Then enter up to eight characters. The new title appears in the title area as you create it.

**SELECT CHAR** enters your character selections for the file title. Turn the analyzer knob or repeatedly press the **STP ONE RIGHT** or **STP ONE LEFT** softkey until the arrow points to your character choice. Press **SELECT CHAR** and the character will appear in the title area.

**SPACE** enters a space character in your file title.

**BACK SPACE** deletes the last character entered in the file title.

**ERASE TITLE** deletes the entire file title.

**STP ONE RIGHT** moves the arrow pointer to the next character to the right.

**STP ONE LEFT** moves the arrow pointer to the next character to the left.

**DONE** terminates entry of the file title and displays the previous menu.

**DELETE FILE** deletes all the files from the directory that have a common title. For example, FILE1. Pressing **DELETE FILE** shows you the active file title. Make sure that the files you wish to delete are active.

**DELETE YES** deletes all files in the directory with the active file title. If you do wish to delete the files with the active file titles, press **DELETE YES**.

**NO** exits the delete file menu without deleting any files. If you want to delete files other than the current active file, use **SELECT TITLE** or the file directory to change the active file title.

## RECALL

**SET UP DISK** presents another menu that lets you set disk unit and volume numbers, initialize disks, and define the format in which to save the data.

**DISK UNIT** shows you the unit of the disk drive where the analyzer expects to find your disk. To change the unit number, use the numeric keypad to enter the new unit number and terminate the entry with the **ENT** key.

**DISK VOLUME** shows you which volume of the disk drive the analyzer will access to save and recall data. To change the volume number, use the numeric keypad to enter the new volume number and terminate the entry with the **ENT** key.

**BINARY FORMAT** sets the measurement and memory data format to binary. Binary format provides the fastest transfer speed of data, includes the detector offset, and uses the smallest storage space of the two formats available (binary and ASCII). The analyzer highlights and underlines the chosen format, and presets to binary format.

**EXT BIN FORMAT** sets the measurement and memory data format to extended binary. Extended binary format extends the range limits beyond the binary format (for ratio, normalized ratio, power and normalized power measurements only). The range extension is a function of the analyzer's detector amplitude offset. This format excludes the detector offset; the value of the detector offset is contained in the instrument state file.

**ASCII FORMAT** sets the measurement and memory data format to ASCII. ASCII format makes the stored data compatible with other computers.

**INIT DISK** lets you initialize a disk. The analyzer will initialize the disk identified by **DISK UNIT** and **DISK VOLUME**. Be certain these are correctly set before continuing.

**INIT YES** begins the initialization. The message **WAITING FOR DISK** appears on the analyzer display. When the disk is initialized, this message disappears and the disk drive light turns off.

---

### Note

For a write-protected disk, the analyzer displays the message **WARNING: DISK IS WRITE PROTECTED**, and the initialization aborts. If you still wish to initialize the disk, remove the write protection and press **INIT DISK** **INIT YES**.

---

**NO** returns the previous menu without running the initialization. It will *not* abort an initialization already in progress.



## PRESET — Preset Key

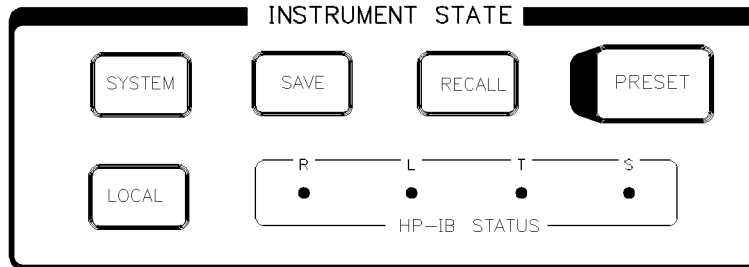

Figure 5-7. PRESET Key

When you press **PRESET**, or when the analyzer receives the IP command from a system controller, the analyzer performs a self-test and then presets all of the instruments connected to the HP 8757 system interface. All of the instrument's functions are turned off and the following states are set:

### Analyzer

- power measurement A on channel 1 (on)
- power measurement B on channel 2 (on)
- power measurement C (or B) on channel 3 (off)
- power measurement R on channel 4 (off)
- measurement data in log magnitude format
- scale = 20 dB/div log; 10 dB/div SWR
- reference level = 0 dBm for all channels log; 1.0 SWR
- reference level step size = 20 dB
- averaging is off
- averaging factor = 8
- cursor is off
- all labels are on
- channel 1 is the active channel
- modulation drive is on
- number of trace points = 401
- detector mode is set for AC detection
- smoothing aperture is set for 5.0% of span (off)
- cursor format = log magnitude

## PRESET

- search value = -3 dB
- adaptive normalization is off
- temperature compensation is on
- autocal is on
- repeat autozero is off
- detector offset = 0 dB
- detector frequency is off
- cursor and delta cursor position = 200
- user start/stop frequency = 50 MHz
- detector start/stop frequency = 50 MHz
- memory offset = 0 dB
- service request mask = 0 (if front panel preset)
- non standard sweep is off
- limit lines are off
- frequency labels are unblanked
- disk format = binary
- detector offset calibrator power = 0 dBm
- non swept CW is off
- manual sweep is off
- stepped sweep is off
- data output format = ASCII

## Source

- instrument preset
- sweep time = 200 ms
- HP 8350B square wave modulation is on
- HP 8340/8341 SHIFT PULSE on; RF output is on
- HP 8360 scalar modulation on; RF output is on

## Plotter

- plot is aborted, if in progress
- P1 and P2 scaling points are unchanged
- selection of plotter pens are unchanged

## Printer

- plot or print is aborted, if in progress

## Disk Drive

- data transfer in progress is aborted
- unit number is unchanged
- volume number is unchanged
- ASCII or binary mode is unchanged

## Unchanged Analyzer Conditions

**PRESET** and the IP command do not change the following analyzer conditions:

- reference position
- trace memory
- save/recall registers
- HP-IB addresses
- service request mask (if remote preset “IP”)
- limit lines
- title
- user-defined plot
- HP 8757 system interface private bus control on/off
- repeat autozero timer
- display intensity
- display colors
- time stamp on/off
- plotter/printer buffer on/off



## Rear Panel Features

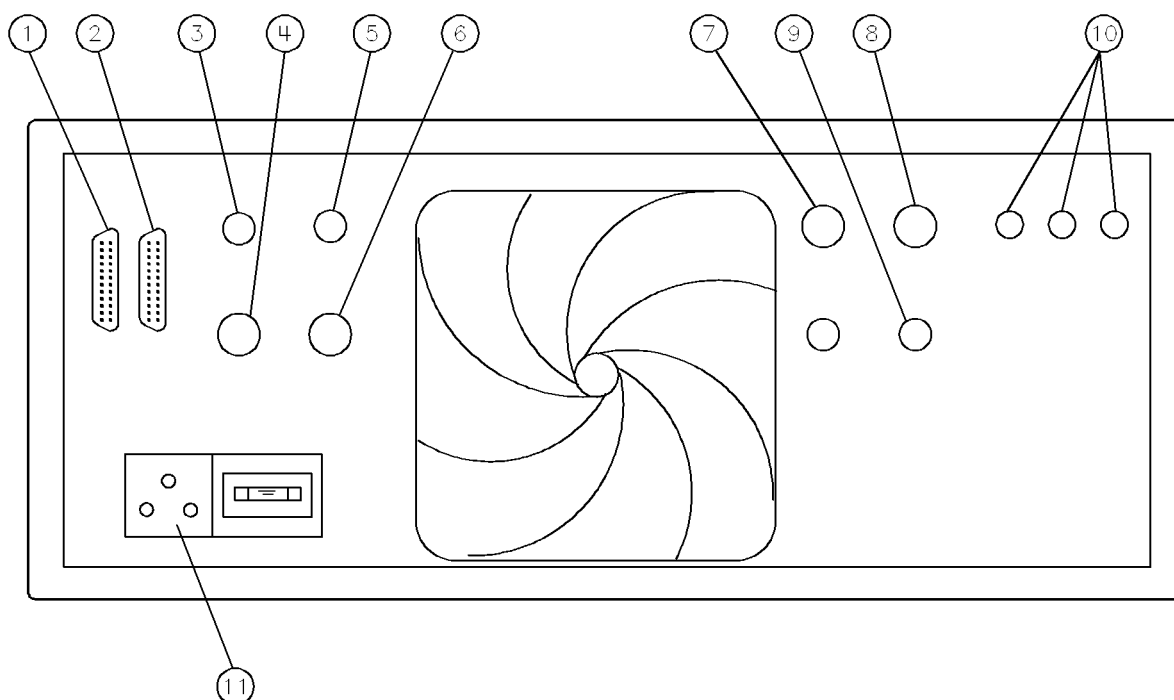

Figure 6-1. The HP 8757D Rear Panel

- ① **8757 SYSTEM INTERFACE** This interface is a private bus that lets the analyzer control peripherals such as the source, plotter, and printer. Since the analyzer itself controls the HP 8757 system interface bus, other controllers must not be attached to this connector, unless the **SYSINTF ON OFF** function is *off*.  
  
With a system interface establishing a communication between the instruments, the analyzer can detect and display the source frequency information.
- ② **HP INTERFACE BUS** This interface bus allows the analyzer to interface with a computer controller and other HP-IB instruments.
- ③ **POS Z BLANK** This input accepts positive retrace, bandswitch blanking, and negative intensity marker (z-axis modulation) signals. The signal levels sensed on this input are +5 V for blanking, 0 V for display, -4 V for markers, and -8 V for the active marker.

## Rear Panel Features

- ④ **SWEEP IN 0-10V** This input accepts a source sweep ramp signal that can be anywhere between 0 to +10 volts. You can modify the A4 ADC assembly so the analyzer can accept sweep ramps greater than +10V. The sweep in signal is necessary for the analyzer to operate as a receiver. An HP 83750 source creates a pulse train that consists of  $1\mu$  second pulses in both continuous and step sweep modes.
- ⑤ **STOP SWEEP** This connector provides the interface signal to stop a source's sweep when it is controlled over the system interface.

The analyzer also uses this connector to sense when the source has stopped the sweep.

- ⑥ **MODULATOR DRIVE** This output provides a 27.778 kHz square wave signal, (nominally  $\pm 6$  V open circuit), for driving an external modulator, a source's external amplitude, or pulse modulation input.
- ⑦ **DAC OUT 0-10V** This connector is provided for future enhancements included with later firmware revisions. You can also use this output for troubleshooting.
- ⑧ **ADC IN** This connector shows an external voltage on the analyzer display using **MEAS AUX**. The connector is also referred to as AUX input. You can also use this input for troubleshooting.
- ⑨ **CONTROL 1 and CONTROL 2** These connectors provide digital output signals (TTL open-collector) as a convenience for driving other peripheral equipment in an HP-IB controlled system. The CONTROL 1 signal can be used as an oscilloscope trigger source when continuous loop service-related tests are performed.
- ⑩ **Internal CRT Display: R, G, and B VIDEO OUTPUT**—These connectors provide analog red, green, and blue video signals that you can use to drive an external color monitor or monochrome monitor. Any analog multisync monitor can be used if it is compatible with the analyzer's 25.5 kHz scan rate and video levels (1 V p-p, 0.7 V = white, 0 V = black,  $-0.3$  V = sync, sync on green).

**Internal LCD-Based Display:** Instruments with the LCD-based display are equipped with a single VGA OUTPUT connector on the rear panel so that an external monitor may be connected. See previous blue tab labeled "Installation," Figure 2-9.

- ⑪ **LINE V  $\pm 10\%$**  This input connector accepts primary line voltage (100, 120, 220, or 240 V) to power the analyzer. Use the printed circuit selector board to set the correct line voltage. See chapter 2, "Installation," for information on line voltage and fuse selection.

## Operator's Check

---

### Equipment Required

HP-IB cable .....	HP 10833A/B/C/D
sweep oscillator mainframe .....	HP 8350B
RF plug-in .....	HP 83592B
detector .....	HP 85037A/B
50 MHz bandpass filter .....	HP PN 08757-80027
graphics plotter .....	HP 7440A

### Description

The operator's check procedure verifies that the analyzer is functioning correctly. It does not verify all of the instrument specifications, but it is an appropriate test for daily instrument verification, incoming inspection, or verification after repair or replacement of digital circuits. The procedure consists of HP-IB and system interface checks, self-tests, and an insertion loss measurement of a standard device.

Save the insertion loss data as a reference for comparison with future operator's checks. Keep the standard device exclusively for these operator's checks to minimize device variation. You can modify this procedure to use other test devices and frequency ranges. But, to test the analyzer's full dynamic range, your source must output +16 dBm.

## Procedure

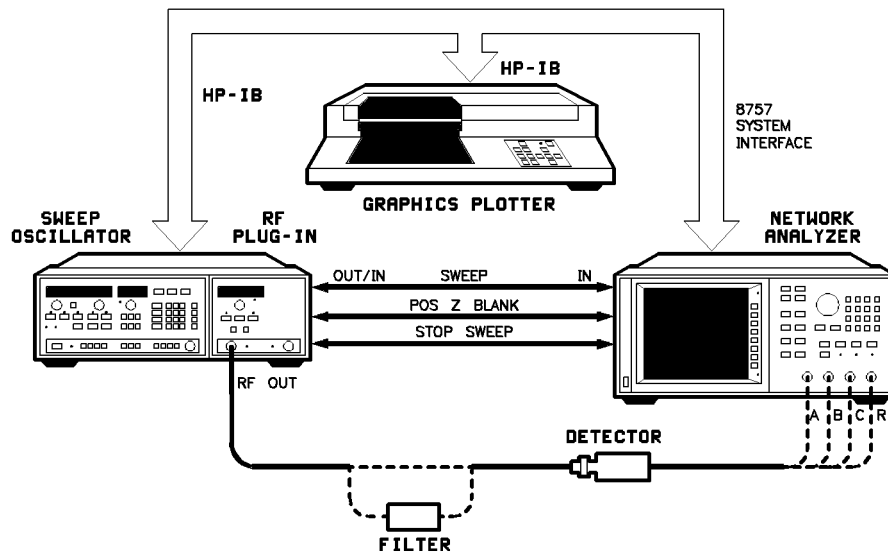

**Figure A-1. Operator's Check Equipment Set-up**

1. To verify the instrument self-test, HP-IB, and system interface, perform the "HP Interface Bus and HP 8757 System Interface" test in chapter 4 of the service manual.
2. Set up the equipment as shown in Figure A-1, with the detector connected to input A of the analyzer. Connect the detector's RF input to the RF output of the source for a "thru" (0 dB insertion loss) connection. Turn on the instruments and allow 30 minutes warm-up time.
3. If the HP 8757 system interface is not engaged (the analyzer status line displays **SYSINTF OFF**), press **(SYSTEM) MORE SWEEP MODE SYSINTF ON**.
4. On the analyzer, press **(PRESET)**. The analyzer channel 1 should be active and measuring input A.
5. Adjust the start and stop frequencies of your source to include the frequency range of your microwave test device.  
These frequencies will be plotted with the data.
6. Turn off the analyzer's channel 2 by pressing **CHANNEL 2** twice.
7. On the analyzer, press **(CURSOR) MAX** to place the cursor at the maximum value of the trace. The **CRSR** value is displayed in the active entry area of the analyzer. Adjust the output power of the RF plug-in until the cursor value on the analyzer reads +16 dBm. This value is the upper limit of the dynamic range of the analyzer.
8. Press **(DISPLAY) MEAS—MEM** to store the trace in memory. The analyzer message line displays **CHAN 1 MEAS TO MEMORY**.



9. Disconnect the detector from the RF output of the source. Press **(AVG) AVG ON OFF** to turn on averaging with an average factor of 8. Wait a few seconds to allow the trace to settle.
10. Press **(CURSOR) MAX**. A cursor value of  $-60$  dBm or lower should be displayed in the active entry area. This is the noise floor power level.
11. Insert your test device between the RF output of the source and the detector. On the analyzer, press **(DISPLAY) MEAS-MEM**. Wait a few seconds to allow the trace to settle.
12. Press **(CURSOR) MAX** to find the trace maximum. The **CRSR** value displayed in the active entry area now represents the minimum insertion loss of your test device. This value will be plotted with the data trace.
13. Press **(SYSTEM) PLOT PLOT ALL** to generate a hard copy plot. Keep this plot for comparison with results of future operator's checks.
14. Disconnect the detector from the A input and connect it to the B input. Remove your test device from the circuit and connect the input of the detector to the RF output of the source. Press **(DISPLAY) MEAS (MEAS) B (AVG) AVG OFF**. Repeat steps 7 through 13.
15. Repeat step 14 for the remaining detector inputs, pressing **(MEAS)** and selecting the softkey that corresponds to the detector input connected.



## Softkey Menu Structure Maps

---

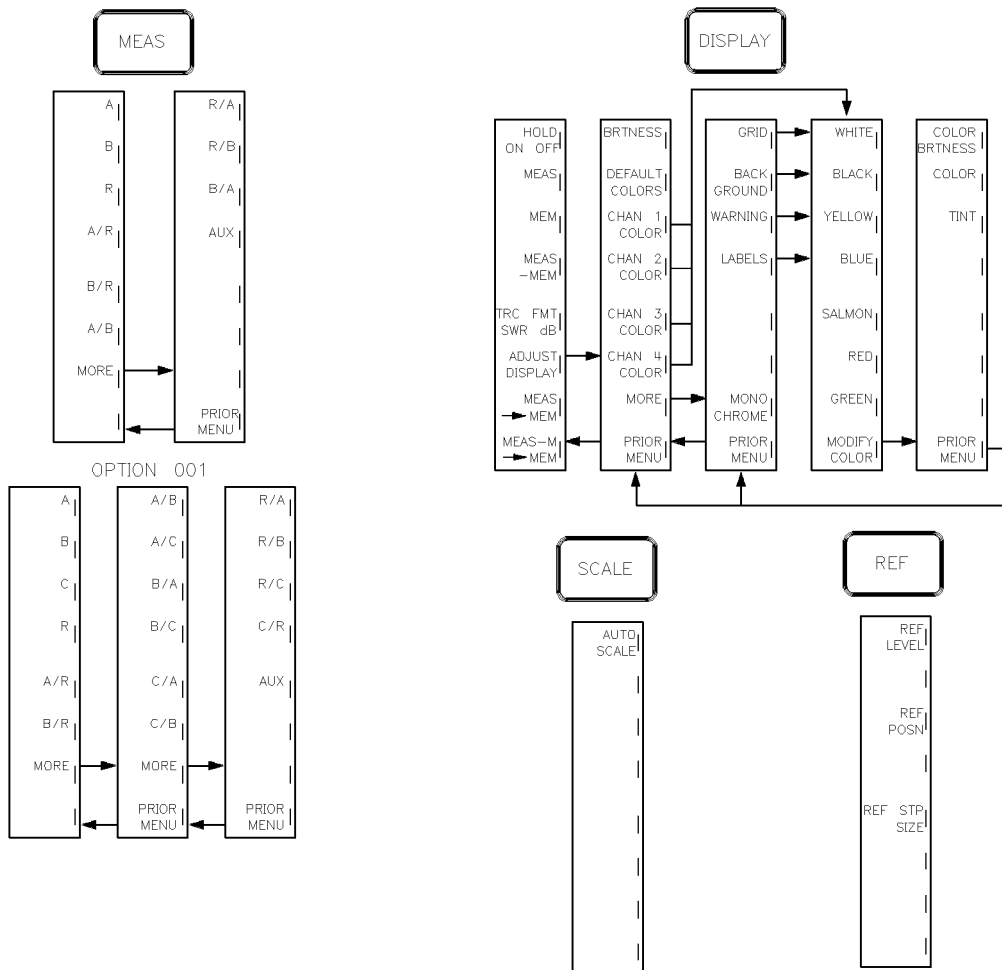
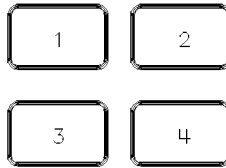

Figure B-1. HP 8757D Softkey Menu Structure Map

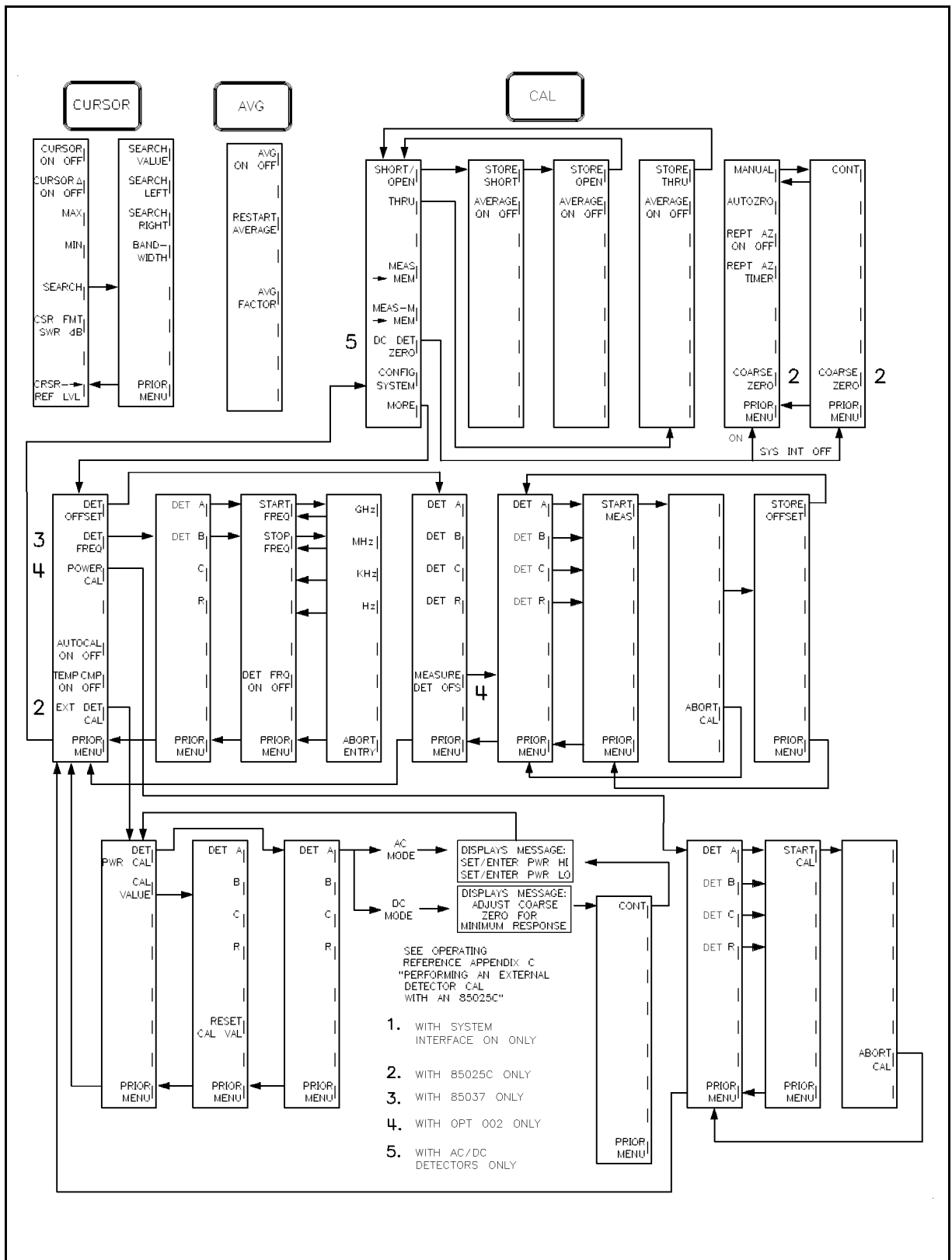

Figure B-2. HP 8757D Softkey Menu Structure Map

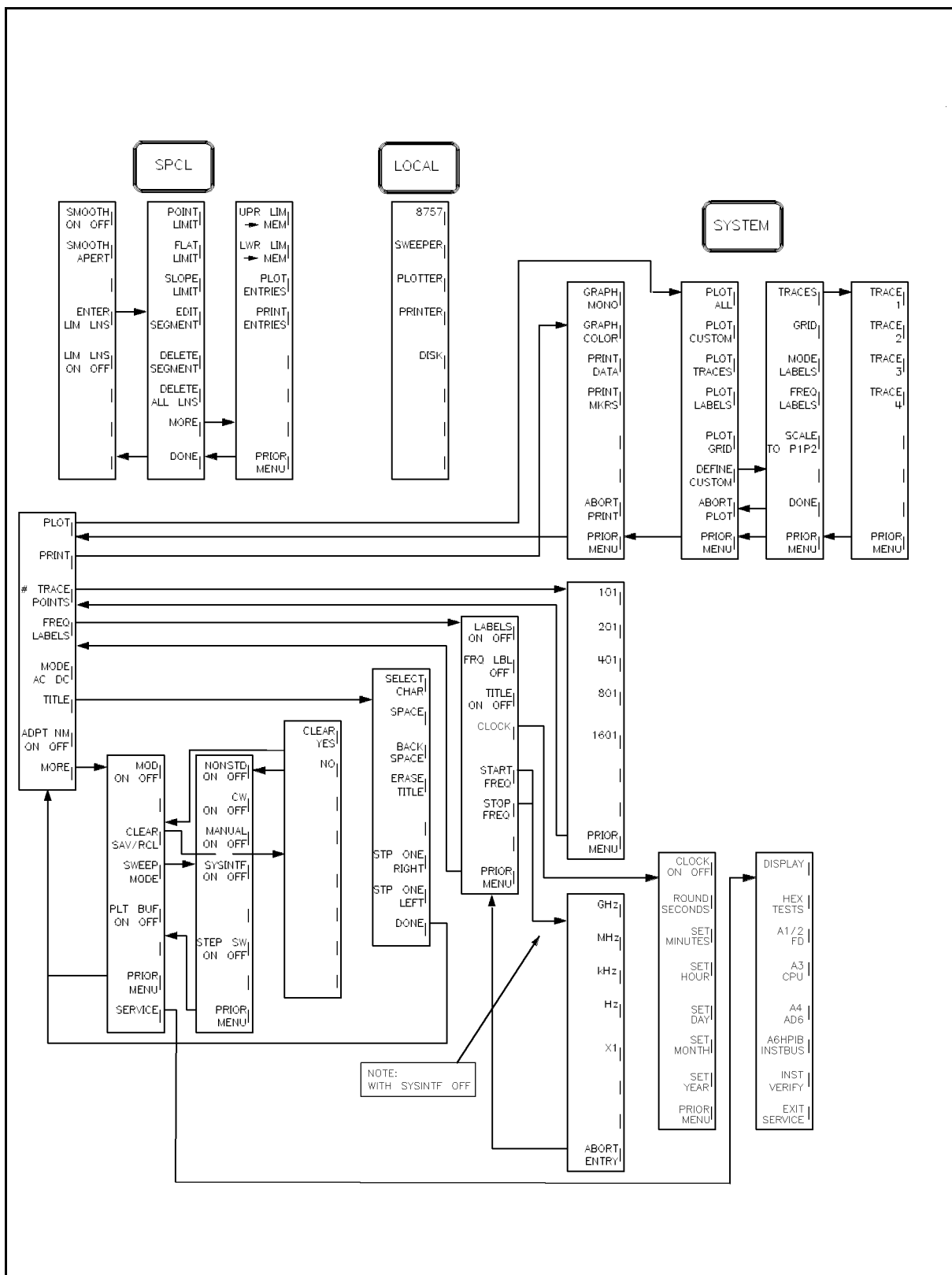

Figure B-3. HP 8757D Softkey Menu Structure Map

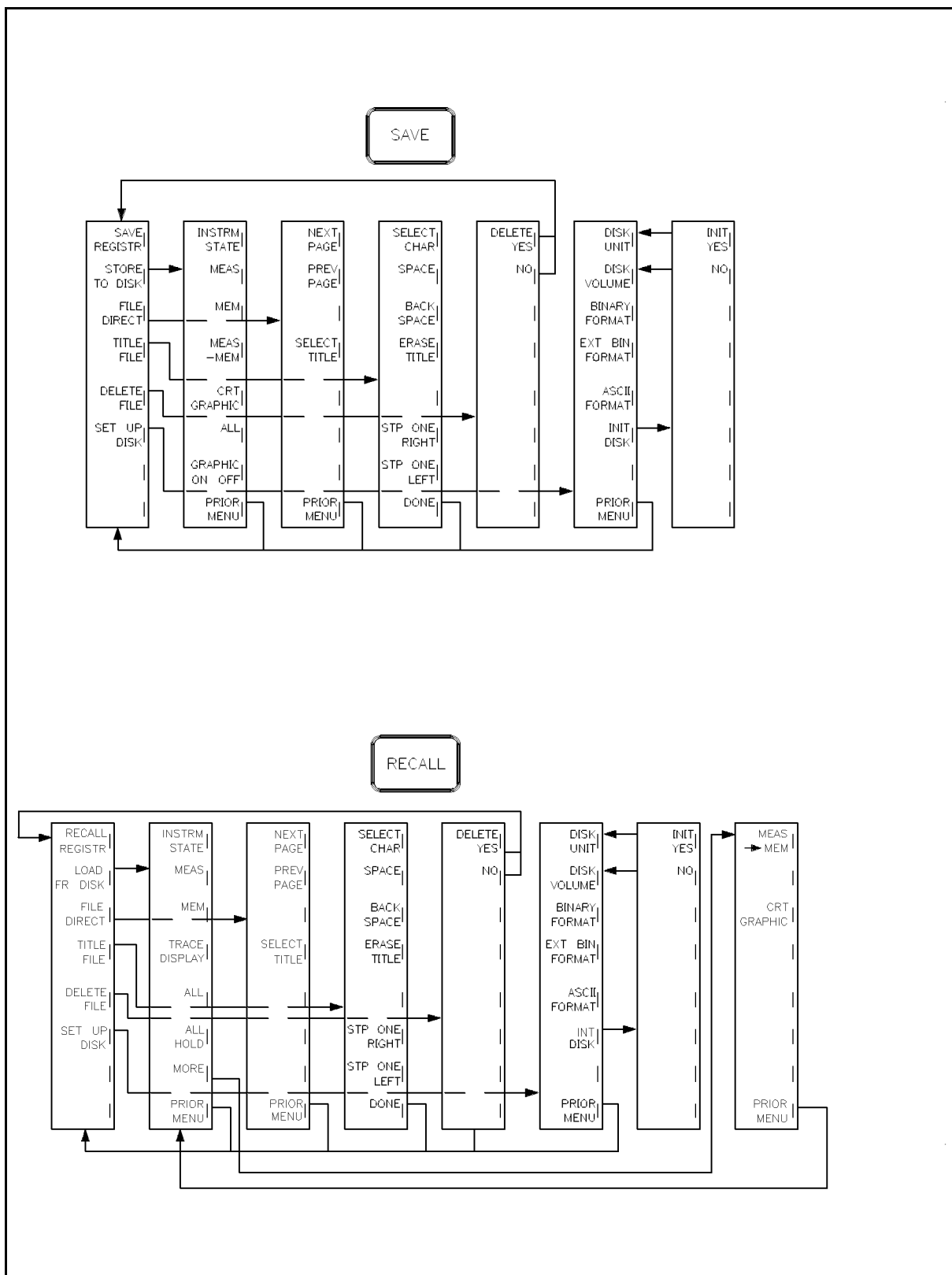

Figure B-4. HP 8757D Softkey Menu Structure Map





## Performing an External Calibration

---

### Performing an External Detector Calibration with an HP 85025C

Because the HP 85025C is used with an external (separate) detector diode, you should perform a firmware based measurement calibration procedure. This external detector measurement calibration procedure calibrates the analyzer's dynamic range to each detector diode and detector adapter. You should perform this procedure whenever you connect a detector diode and adapter to a different input, or if you change either the detector or the adapter.

#### External Detector Measurement Calibration

The response of the diode's output voltage versus input power is described by a general equation within the HP 8757D. To adapt this equation to describe your particular detector, the analyzer uses data measured at two points on the detector's power range. The external detector measurement calibration requires that you measure two different power levels (HI and LO) and that you enter the exact values of the power levels. For best results, the HI power level should be in the diode detector's linear region of operation, and the LO power level should be in its square law region. The power levels +6 and -24 dBm used in the following procedure are typical examples. The power levels you choose depend on the response of your diode detector, and the output power of your source.

#### Equipment required:

- HP 8757D
- HP 85025C detector adapter

#### On the HP 8757D:

1. Connect the equipment and allow 30 minutes warm up.
2. Press **PRESET**.
3. If you will be using DC detection, press **SYSTEM** and select **MODE AC/DC**.  
If you will be using AC detection, continue with Step 4.

NOTE: A measurement calibration in one mode is not valid for the other (see AC versus DC Measurement Calibration below).

4. Press **CAL** **MORE** **EXT DET CAL** **DET PWR CAL**.
5. Select the appropriate input being calibrated, such as **DET A**.

If you are using AC detection, the analyzer displays: ENTER POWER (HI).  
Go to Step 8.

If you are using DC detection, the analyzer displays:  
Adjust COARSE ZERO for minimum response.

**On the HP 85025C:**

6. Adjust COARSE ZERO on the detector for a minimum noise level signal on the analyzer.

**On the HP 8757D:**

7. Select **CONT**.

The analyzer displays ENTER POWER (HI).

8. Connect the detector to an RF source, such as a sweeper.

On the source:

9. Select a CW frequency within the detector's range.
10. Set the power to a level in the detector's square law region greater than  $-10$  dBm (for example,  $+6$  dBm). For best accuracy, use a power meter or HP 85037 detector to set the power level.

**On the HP 8757D:**

13. Enter the power level incident on the detector (for example,  $6$  dBm). The analyzer displays ENTER POWER (LO).

14. Set the attenuator or source power level so that the power to the detector is in the square law region, and less than  $-20$  dBm (for example,  $30$  dB of attenuation).

15. Enter the power level incident on the detector (for example,  $-24$  dBm).

The analyzer performs the external detector measurement calibration and displays the DET A(BCR) CAL VAL when it is finished. Record this value for future reference (on the detector diode and detector adapter, if possible).

If you change the detector or the detector adapter, you must perform a new measurement calibration.

The displayed value is retained by the analyzer as long as an HP 85025C is connected to that input. If another detector diode and adapter is connected to the same input, the analyzer uses the first measurement calibration value until you perform a new measurement calibration.

You can bypass the measurement calibration procedure if you select the softkey **CAL VALUE** rather than **DET PWR CAL** in the measurement calibration sequence, and enter the known value for your detector diode and detector adapter.

## **AC versus DC Measurement Calibration**

A measurement calibration performed in one measurement mode may not be valid in the other mode. For the best measurement accuracy, perform a measurement calibration in the mode you will be using.

The difference between an AC and a DC mode measurement calibration depends on the detector you use. All detectors do not respond the same to a modulated RF signal (used in AC detection), some respond very quickly, while others respond more slowly.

A detector that responds very quickly produces an output signal that has the same amplitude in either AC or DC mode.

A detector that responds more slowly, however, produces an output signal that is smaller in amplitude in AC mode than in DC. Because the signal amplitude is not the same in both measurement modes, a power calibration done in one is not valid in the other.

## Changing a Stored Measurement Calibration

When you perform the measurement calibration procedure, the analyzer stores the calibration value. The analyzer retains that value unless you change it. You can change a calibration value in three ways:

1. Perform an external detector measurement calibration with a new diode and adapter. The new calibration value replaces the original.
2. Enter a known calibration value manually by pressing: **CAL**, **MORE**, **EXT DET CAL**, **CAL VALUE**, **DET A** (or the appropriate input). The analyzer displays **DET A CAL VAL** and the value stored for that input. Enter the value you wish stored for that input and press **ENT**. The analyzer displays **DET A CAL VAL** and the new value.
3. Use the default calibration value that is stored in the analyzer (see “Uncalibrated Operation” below).

Only one measurement calibration value is stored at a time for each input; the analyzer does not keep separate AC and DC calibration values.

## Uncalibrated Operation

When you are making relative measurements at low power levels (in the diode detector’s square law region), you don’t have to perform a measurement calibration. The analyzer has a default calibration value that describes the response of a typical detector diode and adapter. Accurate absolute power measurements, however, do require a calibration.

To set the default value:

Press **CAL**, **MORE**, **EXT DET CAL**, **CAL VALUE**, **DET A** (or the appropriate input) **RESET CAL VAL**.

The analyzer displays **DET A CAL VAL** and the default value.

## Zeroing

When you make DC detection measurements, it is important that you perform a zeroing operation to compensate for the effects of DC drift and temperature fluctuations (this is not required for AC detection). The zeroing operation eliminates small DC voltages from the diode detector that would otherwise cause amplitude measurement errors at low (–40 dBm and below) power levels. Zeroing also establishes the displayed noise level (noise floor of the system) with no RF signal applied.

Zeroing the HP 85025C consists of two parts: (1) coarse zero, which compensates for any large offset voltage, and (2) autozero, which compensates for any small drift in the offset voltage.

### Coarse Zero:

1. Connect the diode and adapter to the analyzer.

### On the HP 8757D:

2. Turn the analyzer on and press **PRESET**. Allow the instruments to warm up for 30 minutes.
3. Press **SYSTEM** **MODE AC/DC** to turn DC mode on.
4. Press **CAL** **DC DET ZERO** **COARSE ZERO**.

5. Select the softkey that corresponds to the detector adapter that you wish to zero (for example, **DET A**). The analyzer displays **Adjust COARSE ZERO** for minimum response.

**On the HP 85025C:**

6. Adjust Coarse DC Zero for a minimum signal on the analyzer.

**Autozero:**

**On the HP 8757D:**

7. After adjusting coarse zero, press the softkey **CONT**. The analyzer performs an autozero.

If the error voltage is too large for autozero to compensate for, the analyzer displays the message:

```
WARNING: DC DET ZERO failed on A(BCR).
```

If this happens, you must adjust coarse zero to bring the error voltage within Autozero range.

Repeat autozero, **REPT AZ ON/OFF**, periodically repeats the autozero. You must use the detector with an HP-IB sweeper to use this function because the HP 8757 must be able to turn off the RF power before performing the autozero.

Manual zero, (**MANUAL**), is similar to zeroing a power meter. First, remove the RF signal from the detector. Then press **MANUAL** to perform the zeroing.

---

**Note** If a device under test generates RF signals or noise, autozero is not valid. Devices that can generate RF energy are microwave amplifiers and mixers with the local oscillator signal applied. If you are testing such devices, use manual zero.

---

**Note** For optimum performance, you should electrically connect the outer conductor of the source RF output connector to the outer conductor of the detector adapter input.

If the operating environment changes significantly, you should repeat the zeroing operation.

---

## Measurement Applications

### Mixer Measurements

Equipment Required

- 2 HP 8360 synthesized sweepers
- HP 85037A/B detector
- HP 85027A/B/C bridge
- HP 11667A/B power splitter

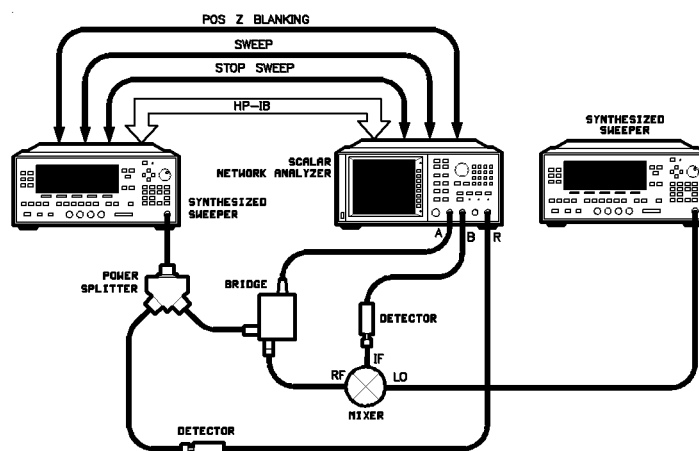

Figure D-1. Mixer Lab Equipment Set-up

#### Note

The figure above shows the connection for the mixer measurements described in case 1 and case 3 in Table D-1.

If you want to make the mixer measurement described in case 2, you must connect a cable between the HP 83750's AUXILIARY INTERFACE connectors and connect a cable between the HP 83750's 10 MHz REF IN/OUT connectors.

Here are three examples of mixer measurements:

1. Swept RF frequency, Fixed LO,  $LO < RF$  Frequency  
(LO is not swept.)
2. Swept LO,  $LO \text{ frequency} = RF - \text{OFFSET}$   
Note: in this case the LO sweeper must be slaved to the RF sweeper.
3. Fixed LO,  $LO > RF$  (The IF signal from the mixer sweeps downward in frequency.)

**Table D-1. Three Mixer Measurement Cases**

CASE	Main Source RF	External Source LO	Mixer IF out
1) Fixed LO, LO < RF	10 to 15 GHz swept	9 GHz fixed	Start 1 GHz to Stop 6 GHz
2) Swept LO, LO=RF-OFFSET	10 to 15 GHz swept	9 GHz to 14 GHz	1 GHz Fixed
3) Fixed LO, LO > RF	10 to 15 GHz swept	16 GHz fixed	Start 6 GHz to Stop 1 GHz

The HP 85037 precision detector has built-in frequency response correction constants. To obtain the best accuracy in mixer measurements, the detector start and stop frequencies should be entered into the HP 8757D using the **DET FREQ** function. If you don't enter the frequencies into the HP 8757, the analyzer uses the source's frequency settings to create the detector's frequency response corrections. This is recommended when you are making mixer measurements because the HP 8757D uses the source's frequency settings to apply the HP 85037 detector's frequency response corrections.

In mixer measurements, the detector operating frequency will most likely be offset from the source frequency. For example, in case 1:

Press:

**CAL**

**MORE**

**DET FREQ DET B**

**START FREQ 1 GHz**

**STOP FREQ 6 GHz**

**DET FREQ ON**

Refer to the **DET FREQ** section in chapter 4 of the "Operating Reference" for more information.